



COMPRAR  
TOLDOS.COM

# HOSTELERÍA 2017



# INFO

## SIMBOLOGÍA



apilable - *empilhável* - stackable - *empilable*



uso interior - *indoor use* - *pour l'intérieur*



protección UV - *proteção UV* - UV protection



uso exterior - *uso ao ar livre* - outdoor use  
*utilisation en extérieur*



abatible - *dobrável* - folding - *pliante*



apilable - *empilhável* - stackable - *empilable*



reguladores de altura - *adjustable leveling feet* -  
régulateurs d'hauteur



desenfundable - *removível* - removable  
*déhoussable*



LET'S SIT  
TOGETHER

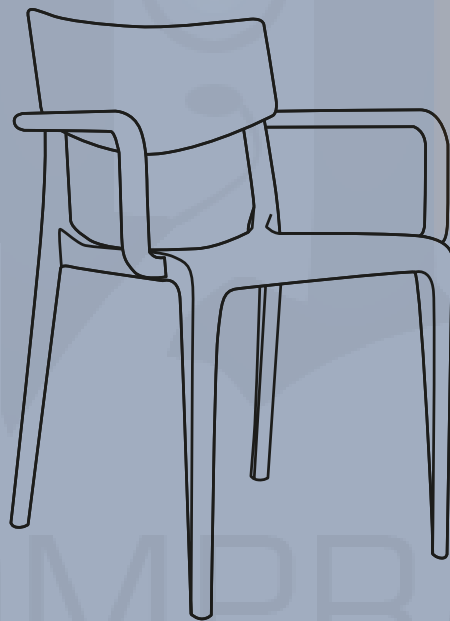

Sillas y Sillones - *Cadeiras* - Chairs and Armchairs - *Chaises et Fauteuils*

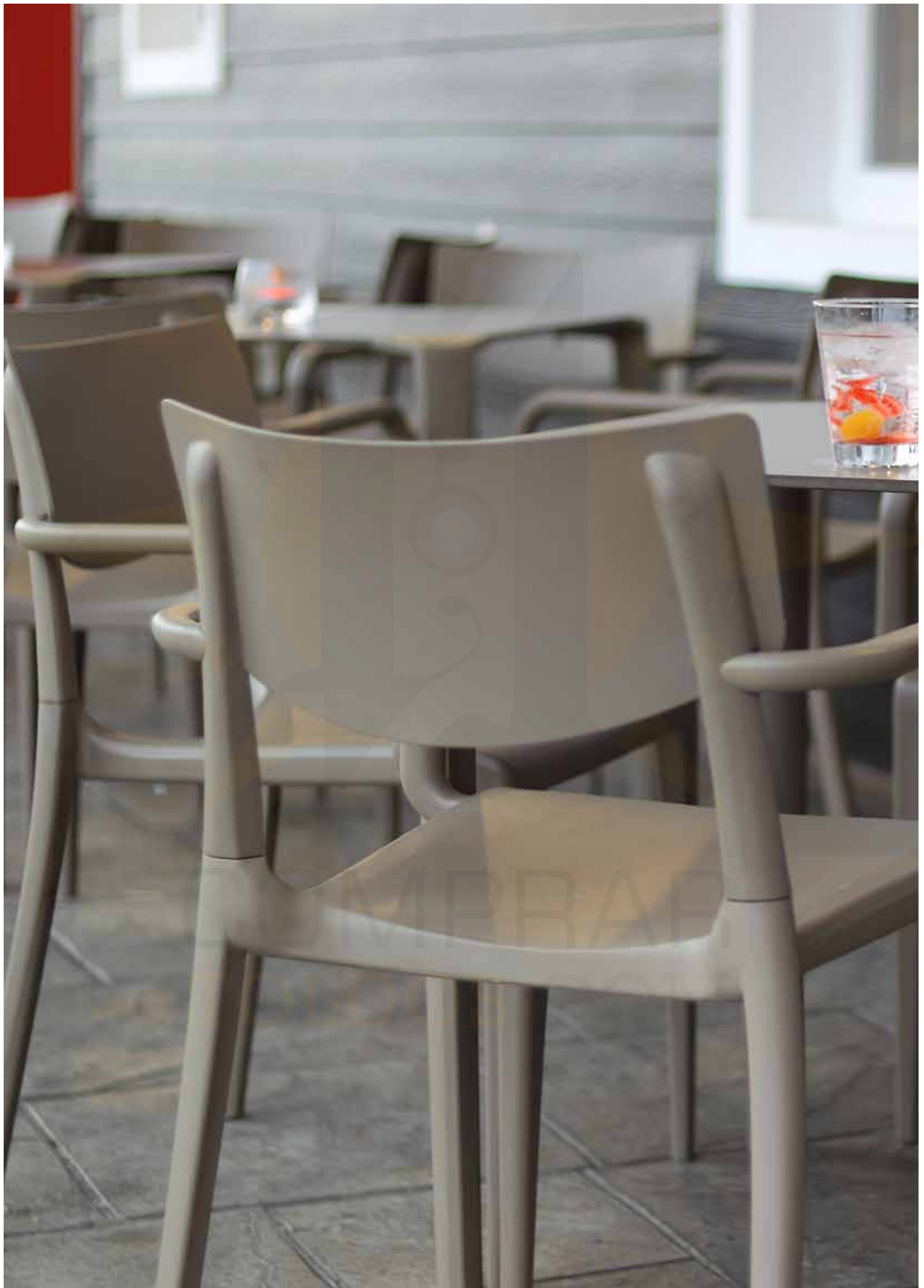



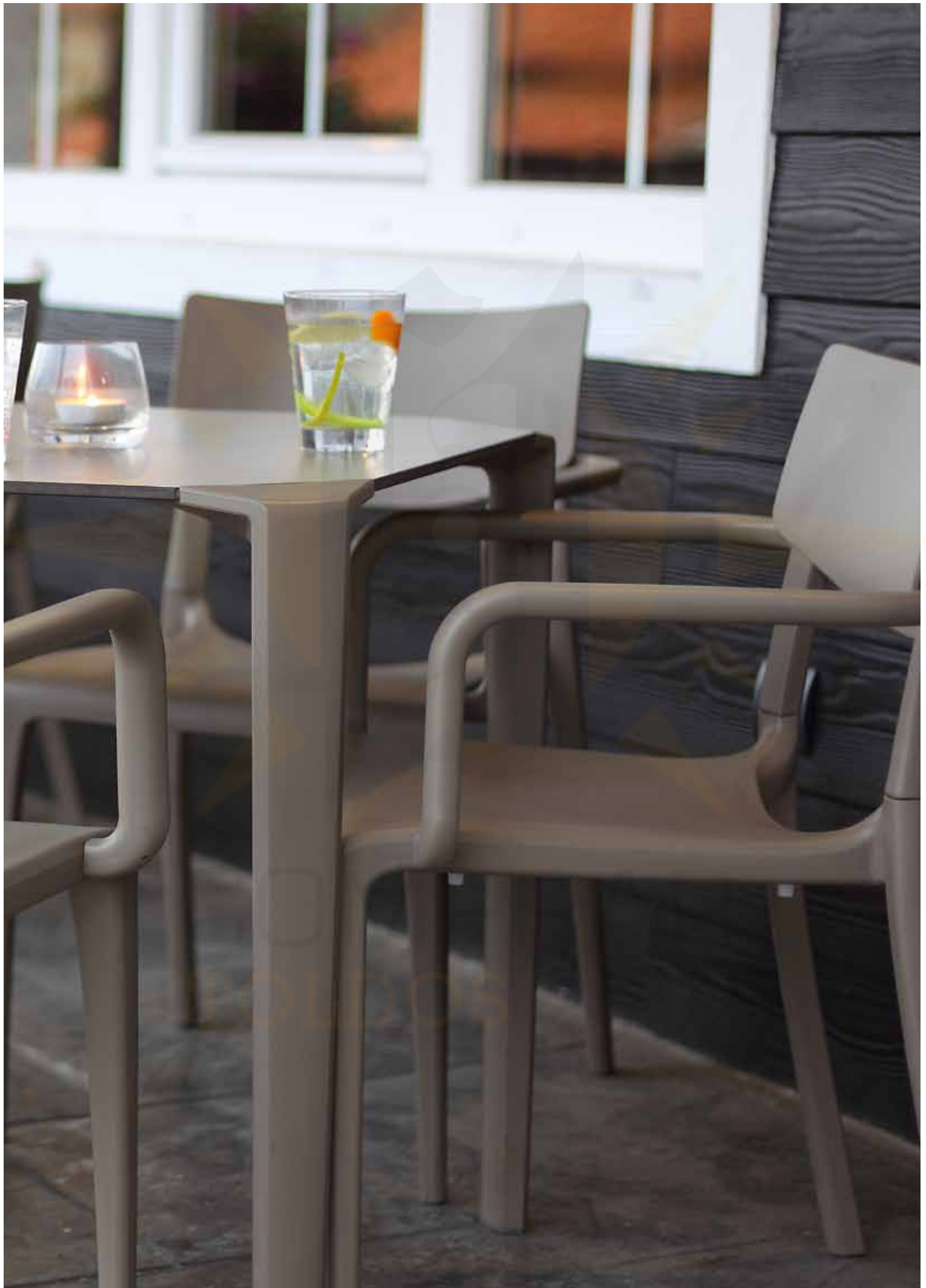



## TOWN

Sillón apilable. Polipropileno reforzado con fibra de vidrio. Inyección por gas.

Cadeira empilhável. Polipropileno reforçado com fibra de vidro. Injeção por gás.

Stackable armchair. Fiber glass reinforced polypropylene. Gas injection.

Fauteuil empilable. Polypropylène renforcé avec fibre de verre. Injection par gaz.

### INFORMACION - INFORMAÇÃO INFORMATION

#### MN-TOW00

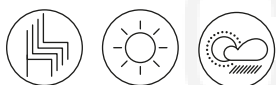

### COLORES - CORES - COLOURS - COULEURS



**010X00**

blanco - branco  
white - blanc



**054X00**

verde - green - vert



**042X00**

cherry



**024X00**

taupe



**091X00**

antracita - anthracite



**064X00**

mostaza - mostarda  
mustard - moutarde



**093X00**

moca - mocha - moka

### MEDIDAS - MEASUREMENTS - MESURES

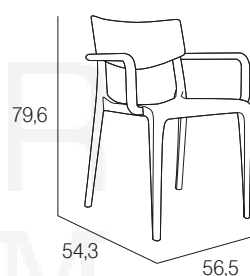

COJÍN RECOMENDADO - ALMOFADA  
RECOMENDADA - RECOMMENDED CUSHION  
- COUSSIN RECOMMANDÉ



**CAY0105130001P1**  
40x40x6 cm





## TOWN

Silla apilable. Polipropileno reforzado con fibra de vidrio. Inyección por gas.

*Cadeira empilhável. Polipropileno reforçado com fibra de vidro. Injeção por gás.*

Stackable chair. Fiber glass reinforced polypropylene. Gas injection.

*Chaise empilable. Polypropylène renforcé avec fibre de verre. Injection par gaz.*

### INFORMACION - INFORMAÇÃO INFORMATION

#### MS-TOW00

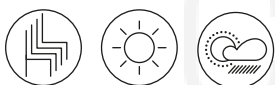

### COLORES - CORES - COLOURS - COULEURS



**010X00**

blanco - branco  
white - blanc



**054X00**

verde - green - vert



**042X00**

cherry



**024X00**

taupe



**091X00**

antracita - anthracite



**064X00**

mostaza - mostarda  
mustard - moutarde



**093X00**

moca - mocha - moka

### MEDIDAS - MEASUREMENTS - MESURES

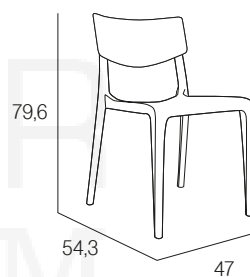

COJÍN RECOMENDADO - ALMOFADA  
RECOMENDADA - RECOMMENDED CUSHION  
- COUSSIN RECOMMANDÉ



**CAY0105130001P1**  
40x40x6 cm





## TOWN PAD

Sillón polipropileno reforzado con fibra de vidrio. Inyección por gas. Asiento tapizado marrón (87% vinilo/13% poliéster). Uso interior.

*Cadeira polipropileno reforçado com fibra de vidro. Injeção por gás. Assento acolchoado castanho (87% vinil/13% poliéster). Uso interior.*

Fiber glass reinforced polypropylene armchair. Gas injection. Brown upholstered seat (87% vinyl/13% polyester). Indoor use.

*Fauteuil en polypropylene renforcé avec fibre de verre. Injection par gaz. Placé d'assise marron (87%vinyl/13% polyester). Pour l'intérieur.*

### INFORMACION - INFORMAÇÃO INFORMATION

**MN-TOW01**



### COLORES - CORES - COLOURS - COULEURS



**054X00**

verde - green - vert



**024X00**

taupe



**093X00**

moca - mocha - moka



**064X00**

mostaza - mostarda  
mustard - moutarde

### MEDIDAS - MEASUREMENTS - MESURES

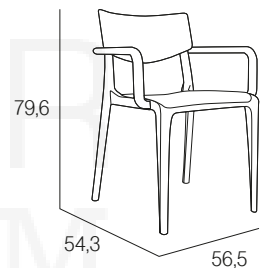

### TAPIZADO - ACOLCHOADO - UPHOLSTERED - TAPISSAGE



marrón - castanho  
brown - marron

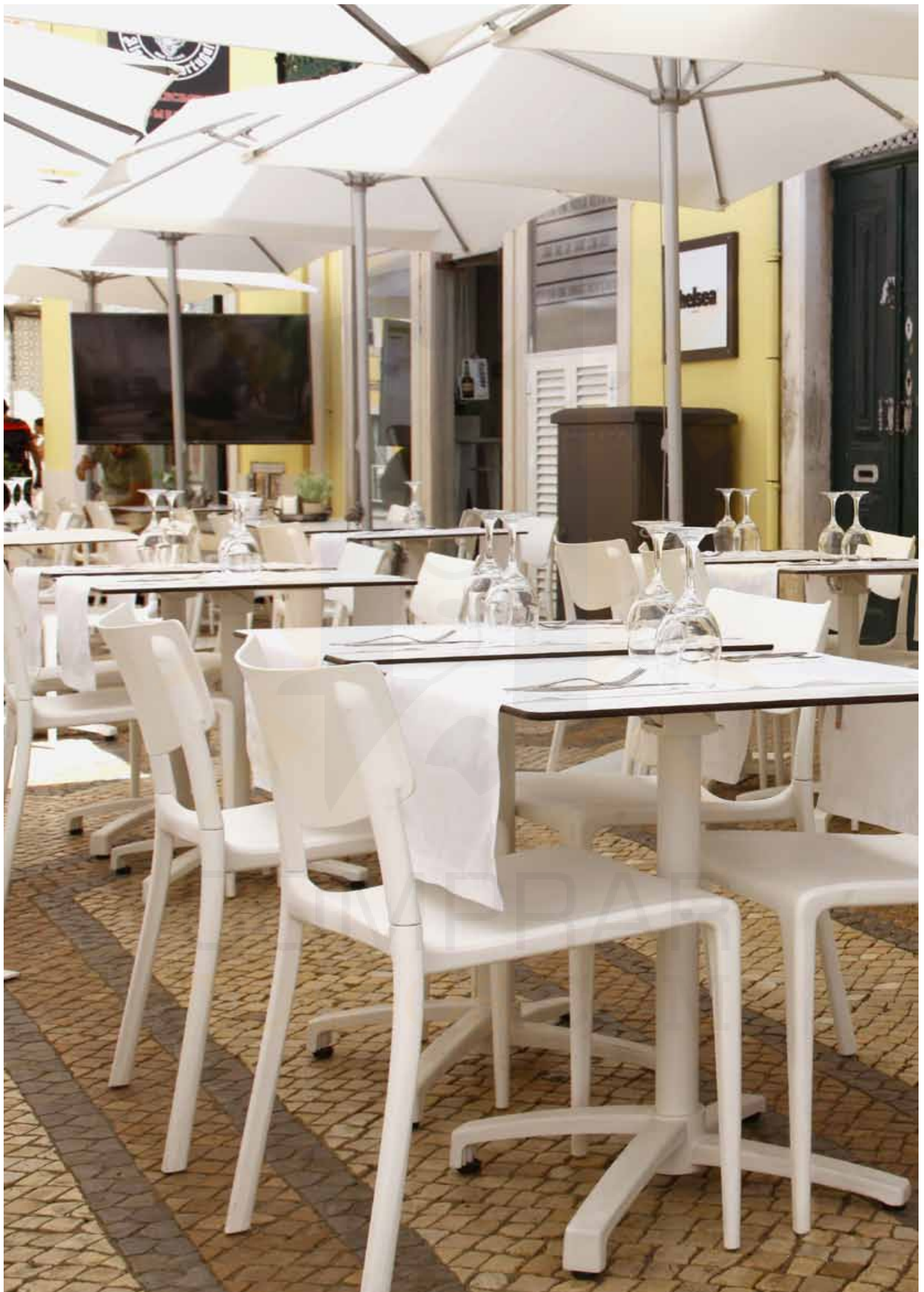







## TOWN PAD

Silla polipropileno reforzado con fibra de vidrio. Inyección por gas. Asiento tapizado marrón (87% vinilo/13% poliéster). Uso interior.

*Cadeira polipropileno reforçado com fibra de vidro. Injeção por gás. Assento acolchoado castanho (87% vinil/13% poliéster). Uso interior.*

Fiber glass reinforced polypropylene chair. Gas injection. Brown upholstered seat (87% vinyl/13% polyester). Indoor use.

*Chaise en polypropylene renforcé avec fibre de verre. Injection par gaz. Placé d'assise marron (87%vinyl/13% polyester). Pour l'intérieur.*

### INFORMACION - INFORMAÇÃO INFORMATION

**MS-TOW01**



### COLORES - CORES - COLOURS - COULEURS



**054X00**

verde - green - vert



**024X00**

taupe



**093X00**

moca - mocha - moka



**064X00**

mostaza - mostarda  
mustard - moutarde

### MEDIDAS - MEASUREMENTS - MESURES

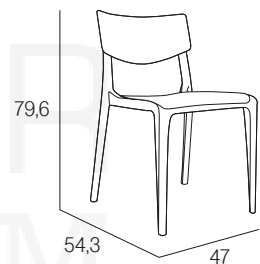

### TAPIZADO - ACOLCHOADO - UPHOLSTERED - TAPISSAGE



marrón - castanho  
brown - marron









## PARK

Sillón apilable. Polipropileno reforzado con fibra de vidrio. Inyección por gas.

Cadeira empilhável. Polipropileno reforçado com fibra de vidro. Injeção por gás.

Stackable armchair. Fiber glass reinforced polypropylene. Gas injection.

Fauteuil empilable. Polypropylène renforcé avec fibre de verre. Injection par gaz.

### INFORMACION - INFORMAÇÃO INFORMATION

#### MN-PAROO

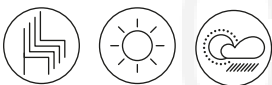

### COLORES - CORES - COLOURS - COULEURS



**010X00**

blanco - branco  
white - blanc



**091X00**

antracita - anthracite



**042X00**

cherry



**024X00**

taupe



**083X00**

ocean

### MEDIDAS - MEASUREMENTS - MESURES

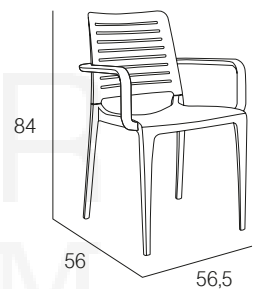

COJÍN RECOMENDADO - ALMOFADA  
RECOMENDADA - RECOMMENDED CUSHION  
- COUSSIN RECOMMANDÉ



**CAYO105130001P1**  
40x40x6 cm



## PARK

Silla apilable. Polipropileno reforzado con fibra de vidrio. Inyección por gas.

Cadeira empilhável. Polipropileno reforçado com fibra de vidro. Injeção por gás.

Stackable chair. Fiber glass reinforced polypropylene. Gas injection.

Chaise empilable. Polypropylène renforcé avec fibre de verre. Injection par gaz.

### INFORMACION - INFORMAÇÃO INFORMATION

#### MS-PAR00

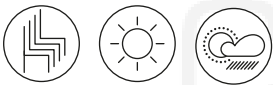

### COLORES - CORES - COLOURS - COULEURS



**010X00**

blanco - branco  
white - blanc



**091X00**

antracita - anthracite



**042X00**

cherry



**024X00**

taupe



**083X00**

ocean

### MEDIDAS - MEASUREMENTS - MESURES

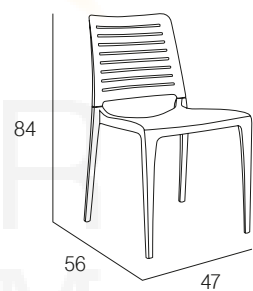

COJÍN RECOMENDADO - ALMOFADA  
RECOMENDADA - RECOMMENDED CUSHION  
- COUSSIN RECOMMANDÉ



**CAYO105130001P1**  
40 x 40 x 6 cm











## HALL

Sillón apilable. Polipropileno reforzado con fibra de vidrio. Inyección por gas.

*Cadeira empilhável. Polipropileno reforçado com fibra de vidro. Injeção por gás.*

Stackable armchair. Fiber glass reinforced polypropylene. Gas injection.

*Fauteuil empilable. Polypropylène renforcé avec fibre de verre. Injection par gaz.*

### INFORMACION - INFORMAÇÃO INFORMATION

#### MN-HALOO

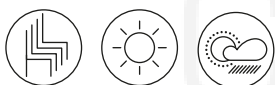

### COLORES - CORES - COLOURS - COULEURS



**010X00**

blanco - branco  
white - blanc



**091X00**

antracita - anthracite



**042X00**

cherry



**024X00**

taupe

### MEDIDAS - MEASUREMENTS - MESURES

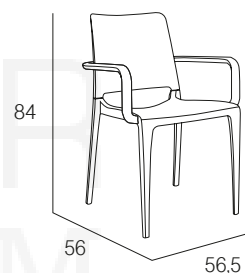

COJÍN RECOMENDADO - ALMOFADA  
RECOMENDADA - RECOMMENDED CUSHION  
- COUSSIN RECOMMANDÉ



**CAYO105130001P1**  
40x40x6 cm



## HALL

Silla apilable. Polipropileno reforzado con fibra de vidrio. Inyección por gas.

Cadeira empilhável. Polipropileno reforçado com fibra de vidro. Injeção por gás.

Stackable chair. Fiber glass reinforced polypropylene. Gas injection.

Chaise empilable. Polypropylène renforcé avec fibre de verre. Injection par gaz.

### INFORMACION - INFORMAÇÃO INFORMATION

#### MS-HALOO

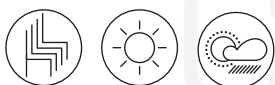

### COLORES - CORES - COLOURS - COULEURS



**010X00**

blanco - branco  
white - blanc



**091X00**

antracita - anthracite



**042X00**

cherry



**024X00**

taupe

### MEDIDAS - MEASUREMENTS - MESURES

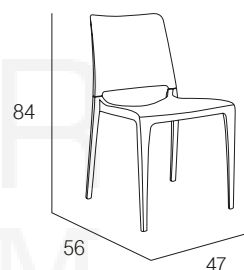

COJÍN RECOMENDADO - ALMOFADA  
RECOMENDADA - RECOMMENDED CUSHION  
- COUSSIN RECOMMANDÉ



**CAYO105130001P1**  
40x40x6 cm









## BOWL WOOD

Sillón apilable. Polipropileno. Patas de madera. Uso interior.  
*Cadeira empilhável. Polipropileno. Pés em madeira. Uso interior.*  
Stackable armchair. Polypropylene. Wooden legs. Indoor use.  
*Fauteuil empilable. Polypropylène. Pieds en bois. Pour l'intérieur.*

### INFORMACION - INFORMAÇÃO INFORMATION

#### MN-BOW03

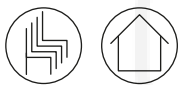

### COLORES - CORES - COLOURS - COULEURS



**MN-BOW03-010X00**

blanco - branco  
white - blanc



**MN-BOW03-090X00**

negro - preto  
black - noir

### MEDIDAS - MEASUREMENTS - MESURES

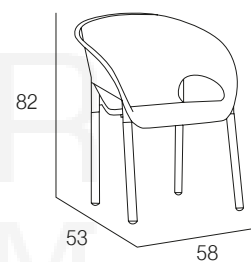

COJÍN RECOMENDADO - ALMOFADA  
RECOMENDADA - RECOMMENDED CUSHION  
- COUSSIN RECOMMANDÉ



**OLEFIN**  
FIBER

**CAYO102670001P1**  
45 x 45 x 3,5 + 2 cm





## BOWL

Sillón apilable. Polipropileno. Patas de aluminio lacado.  
*Cadeira empilhável. Polipropileno. Pés em alumínio lacado.*  
Stackable armchair. Polypropylene. Laquered aluminium legs.  
*Fauteuil empilable. Polypropylène. Pieds en aluminium laqué.*

INFORMACION - INFORMAÇÃO  
INFORMATION

**MN-BOW01 - MN-BOW02**

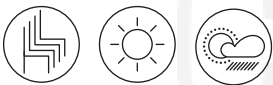

COLORES - CORES - COLOURS - COULEURS

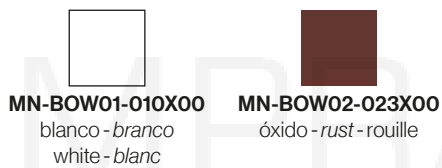

MEDIDAS - MEASUREMENTS - MESURES

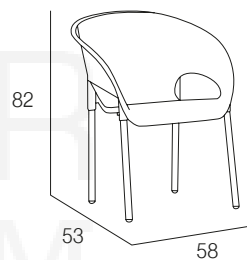

COJÍN RECOMENDADO - ALMOFADA  
RECOMENDADA - RECOMMENDED CUSHION  
- COUSSIN RECOMMANDÉ



**CAYO102670001P1**  
45 x 45 x 3,5 + 2 cm



## LAND\_TEX

Sillón apilable. Aluminio lacado. Tejido Phifertex®.

Cadeira empilhável. Alumínio lacado. Tecido Phifertex®.

Stackable armchair. Lacquered aluminium. Phifertex® fabric.

Fauteuil empilable. Aluminium laqué. Tissu Phifertex®.

### INFORMACION - INFORMAÇÃO INFORMATION

#### MN-LAN00

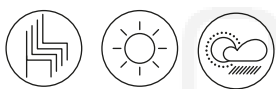

### COLORES - CORES - COLOURS - COULEURS



**010T11**  
blanco - branco  
white - blanc



**020T11**  
taupe

**PHIFERTEX**  
Outdoor Fabrics

### MEDIDAS - MEASUREMENTS - MESURES

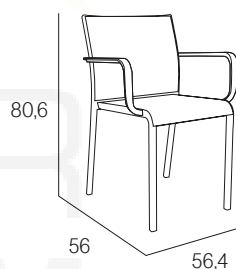

COJÍN RECOMENDADO - ALMOFADA  
RECOMENDADA - RECOMMENDED CUSHION  
- COUSSIN RECOMMANDÉ



**OLEFIN**  
FIBER

**CAEO10816001P1**  
42 x 42 x 5 cm



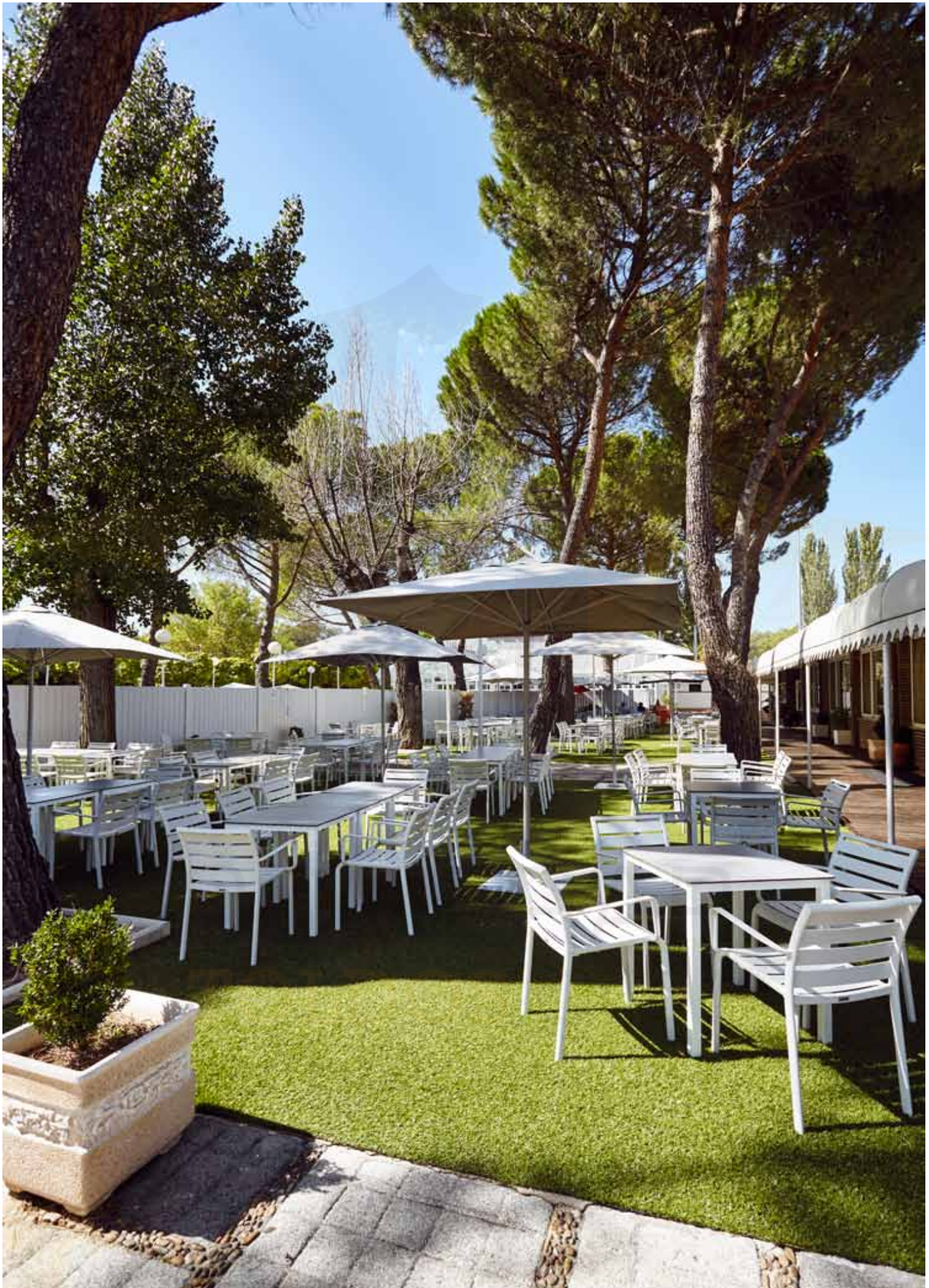





## LAND\_SLATS

Sillón apilable. Aluminio lacado. Lamas de aluminio.

*Cadeira empilhável. Alumínio lacado. Ripas de alumínio.*

Stackable armchair. Lacquered aluminium. Aluminium slats.

*Fauteuil empilable. Aluminium laqué. Lamelles en aluminium.*

### INFORMACION - INFORMAÇÃO INFORMATION

**MN-LAN01**



### COLORES - CORES - COLOURS - COULEURS



**010A03**  
blanco - branco  
white - blanc



**020A03**  
taupe

### MEDIDAS - MEASUREMENTS - MESURES

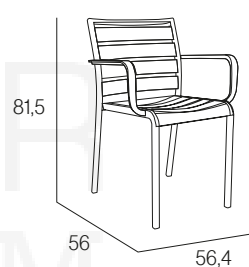

COJÍN RECOMENDADO - ALMOFADA  
RECOMENDADA - RECOMMENDED CUSHION  
- COUSSIN RECOMMANDÉ



**OLEFIN**  
FIBER

**CAEO10816001P1**  
42 x 42 x 5 cm







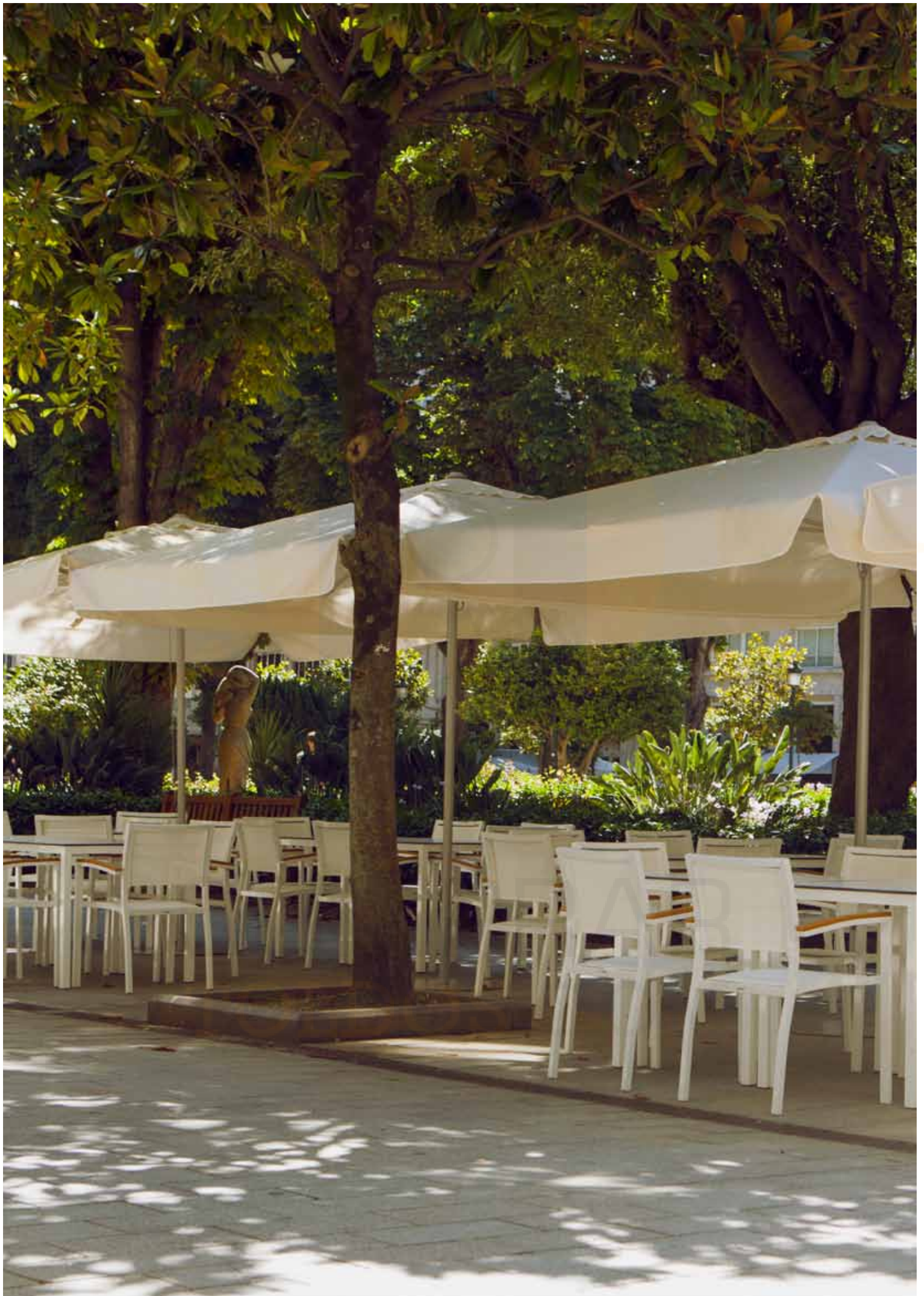

NEW



## MONACO PREMIUM

Sillón apilable. Aluminio lacado. Phifertex®. Reposabrazos de eco-wood.  
Cadeira empilhável. Alumínio lacado. Phifertex®. Reposa braços em eco-wood.  
Stackable armchair. Lacquered aluminium. Phifertex®. Eco-wood armrests.  
Fauteuil empilable. Aluminium laqué. Phifertex®. Repose-bras en eco-wood.

### INFORMACION - INFORMAÇÃO INFORMATION

**MN-MON01**



### COLORES - CORES - COLOURS - COULEURS



**010T11**

blanco - branco  
white - blanc



**091T11**

antracita - anthracite

**PHIFERTEX**  
Outdoor Fabrics

### MEDIDAS - MEASUREMENTS - MESURES

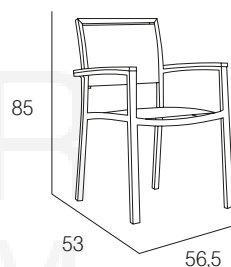

COJÍN RECOMENDADO - ALMOFADA  
RECOMENDADA - RECOMMENDED CUSHION  
- COUSSIN RECOMMANDÉ



**CAEO10816001P1**  
42 x 42 x 5 cm

**OLEFIN**  
FIBER









## MONACO

Sillón apilable. Aluminio lacado gris. Textilene. Reposabrazos de eco-wood.

Cadeira empilhável. Alumínio lacado cinza. Textilene. Repousa braços em eco-wood.

Stackable armchair. Grey lacquered aluminium. Textilene. Eco-wood armrests.

Fauteuil empilable. Aluminium laqué gris. Textilene. Repose-bras en eco-wood.

### INFORMACION - INFORMAÇÃO INFORMATION

#### MN-MONOO



### COLORES - CORES - COLOURS - COULEURS



**010T21**  
blanco - branco  
white - blanc



**030T21**  
gris - cinza - grey  
gris



**001T21**  
beige - bege



**090T21**  
negro - preto - black  
noir

### MEDIDAS - MEASUREMENTS - MESURES

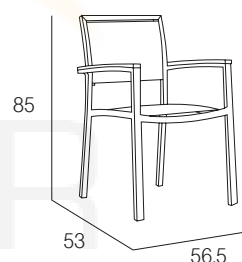

COJÍN RECOMENDADO - ALMOFADA  
RECOMENDADA - RECOMMENDED CUSHION  
- COUSSIN RECOMMANDÉ



**OLEFIN**  
FIBER

**CAEO10816001P1**  
42x42x5 cm





## SICILIA

Sillón apilable. Aluminio lacado. Lamas asiento en eco-wood.  
*Cadeira empilhável. Alumínio lacado. Ripas assento em eco-wood.*  
Stackable armchair. Lacquered aluminium. Eco-wood seat slats.  
*Fauteuil empilable. Aluminium laqué. Lamelles siège en eco-wood.*

### INFORMACION - INFORMAÇÃO INFORMATION

#### MN-SIC00



### COLORES - CORES - COLOURS - COULEURS



**011J00**  
blanco - branco  
white - blanc



**042J00**  
óxido - rust - rouille

### MEDIDAS - MEASUREMENTS - MESURES

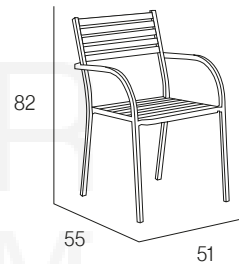

COJÍN RECOMENDADO - ALMOFADA  
RECOMENDADA - RECOMMENDED CUSHION  
- COUSSIN RECOMMANDÉ



**CAYO105130001P1**  
40 x 40 x 6 cm



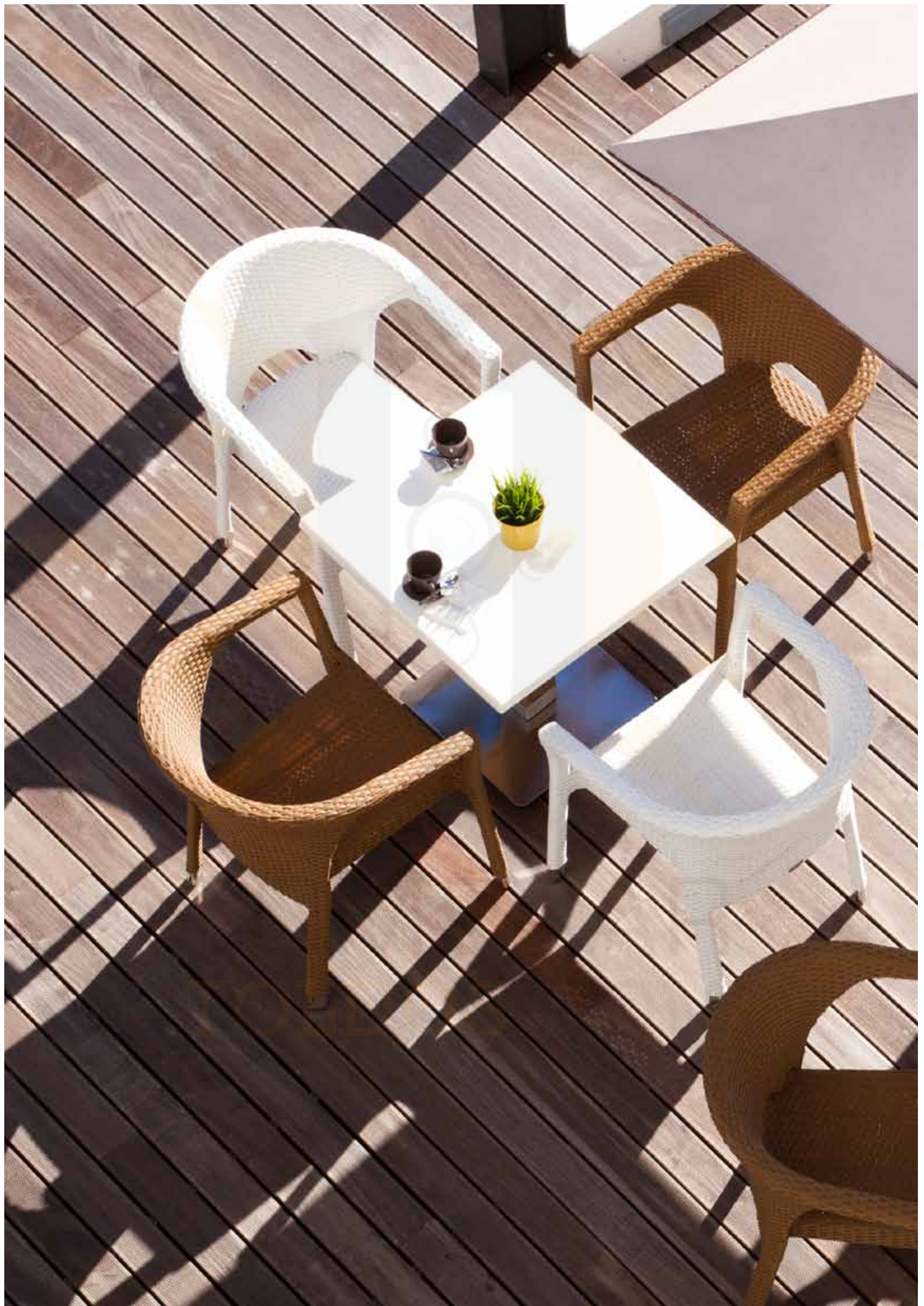



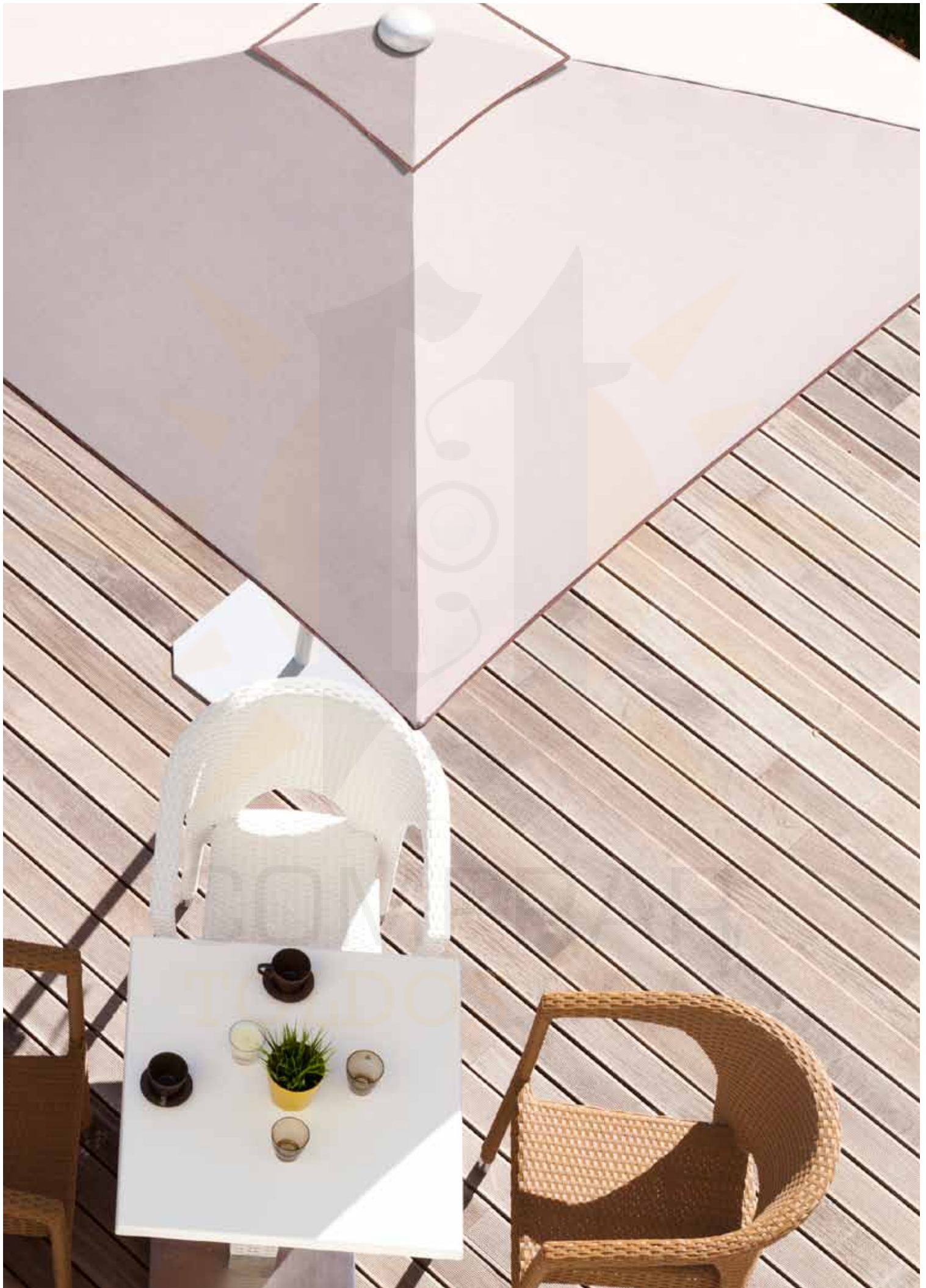



## CAPRI

Sillón apilable. Aluminio. Ratán plano rústico.

*Cadeira empilhável. Alumínio. Ratan plano rústico.*

Stackable armchair. Aluminium. Flat rustic rattan.

*Fauteuil empilable. Aluminium. Rattan plat rustique.*

INFORMACION - INFORMAÇÃO  
INFORMATION

**MN-CAPOO**



COLORES - CORES - COLOURS - COULEURS



**023R31**  
marrón - castanho  
brown - marron

MEDIDAS - MEASUREMENTS - MESURES

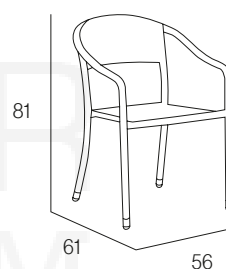

COJÍN RECOMENDADO - ALMOFADA  
RECOMENDADA - RECOMMENDED CUSHION  
- COUSSIN RECOMMANDÉ



**OLEFIN**  
FIBER

**CAEO10816001P1**  
42 x 42 x 5 cm







## ROMA

Sillón apilable. Aluminio. Ratán 4 vías.

Cadeira empilhável. Alumínio. Ratan 4 vias.

Stackable armchair. Aluminium. 4 in 1 rattan.

Fauteuil empilable. Aluminium. Rattan 4 lignes.

### INFORMACION - INFORMAÇÃO INFORMATION

#### MN-ROM00



### COLORES - CORES - COLOURS - COULEURS



**010R50**

blanco - branco  
white - blanc



**090R50**

negro - preto - black  
noir



**021R50**

café - coffee

### MEDIDAS - MEASUREMENTS - MESURES

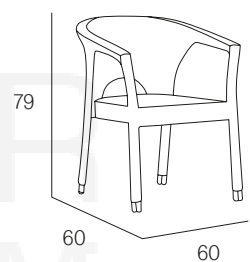

COJÍN RECOMENDADO - ALMOFADA  
RECOMENDADA - RECOMMENDED CUSHION  
- COUSSIN RECOMMANDÉ



**OLEFIN**  
FIBER

**CPN-ROM010001P1**  
48 x 50 x 5 cm



## BERLIN

Sillón apilable. Aluminio. Ratán 4 vías/ratán plano rústico.

Cadeira empilhável. Alumínio. Ratan 4 vias/ratan plano rústico.

Stackable armchair. Aluminium. 4 in 1 rattan/flat rustic rattan.

Fauteuil empilable. Aluminium. Rattan 4 lignes/rattan plat rustique.

INFORMACION - INFORMAÇÃO  
INFORMATION

**MN-BER01/BER02**



COLORES - CORES - COLOURS - COULEURS  
4x1



**010R50**

blanco - branco  
white - blanc



**091R50**

antracita - anthracite

COLORES - CORES - COLOURS - COULEURS  
rustic



**023R31**

marrón - castanho  
brown - marron



MEDIDAS - MEASUREMENTS - MESURES

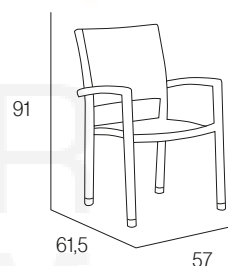

COJÍN RECOMENDADO - ALMOFADA  
RECOMENDADA - RECOMMENDED CUSHION  
- COUSSIN RECOMMANDÉ



**CAEO10816001P1**  
42 x 42 x 5 cm





## NIZA

Sillón apilable. Aluminio. Ratán 4 vías.

Cadeira empilhável. Alumínio. Ratan 4 vias.

Stackable armchair. Aluminium. 4 in 1 rattan.

Fauteuil empilable. Aluminium. Rattan 4 lignes.

### INFORMACION - INFORMAÇÃO INFORMATION

#### MN-NIZOO



### COLORES - CORES - COLOURS - COULEURS



**010R50**

blanco - branco  
white - blanc



**090R50**

negro - preto  
black - noir



**021R50**

café - coffee

### MEDIDAS - MEASUREMENTS - MESURES

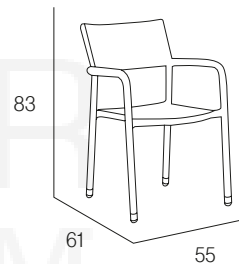

COJÍN RECOMENDADO - ALMOFADA  
RECOMENDADA - RECOMMENDED CUSHION  
- COUSSIN RECOMMANDÉ



**OLEFIN**  
FIBER

**CAEO10816001P1**  
42 x 42 x 5 cm







## BERLIN

Taburete apilable con respaldo. Aluminio. Ratán 4 vías.  
*Banco alto empilhável com encosto. Alumínio. Ratan 4 vías.*  
Stackable stool with backrest. Aluminium. 4 in 1 rattan.  
*Tabouret empilable avec dossier. Aluminium. Rattan 4 lignes.*

INFORMACION - INFORMAÇÃO  
INFORMATION

**MT-BERO1**



COLORES - CORES - COLOURS - COULEURS



**010R50**  
blanco - branco  
white - blanc



**091R50**  
antracita - anthracite

MEDIDAS - MEASUREMENTS - MESURES

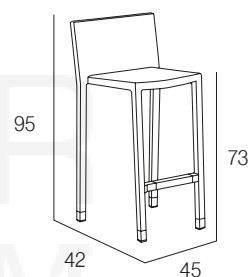





TIME TO EAT

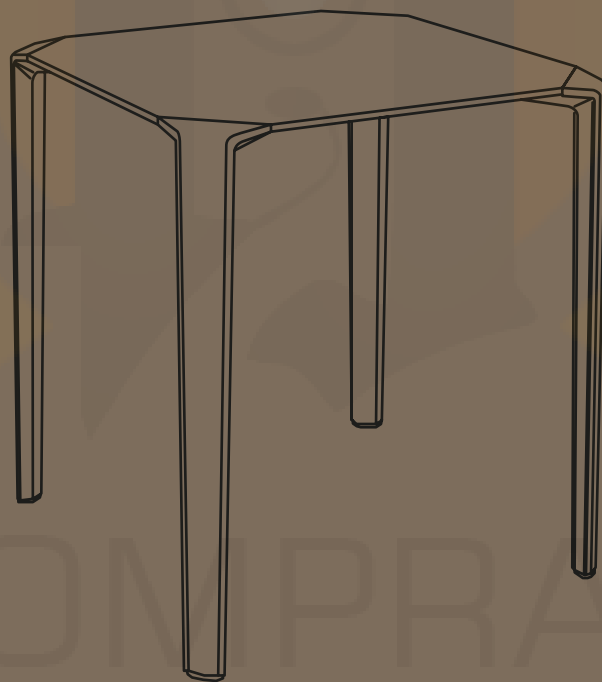

COMPRAR  
TOLDOS.COM

Mesas - *Tables*











## QUATRO

Mesa abatible. Patas de polipropileno reforzado con fibra de vidrio. Tubo de aluminio lacado. Reguladores de altura.

*Mesa dobrável. Pés de polipropileno reforçado com fibra de vidro. Tubo de alumínio lacado. Reguladores de altura.*

Folding table. Legs in fiber glass reinforced polypropylene. Laquered aluminium tube. Adjustable leveling feet.

*Table pliante. Piètement en polypropylène renforcé avec fibre de verre. Tube aluminium laqué. Régulateurs d' hauteur.*

### INFORMACION - INFORMAÇÃO INFORMATION

**60x60 - 70x70 - ø60 - ø70**



### COLORES - CORES - COLOURS - COULEURS



**40QUA00**  
blanco - branco  
white - blanc



**40QUA01**  
antracita - anthracite



**40QUA03**  
taupe



**40QUA02**  
moca - mocha - moka

### MEDIDAS - MEASUREMENTS - MESURES

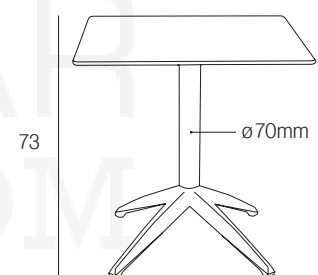

TABLEROS - TAMPOS - TOPS - PLATEAUX  
PAG.63

**COMPACT** **INDORTEC**  
ø60 - 70x70



## QUATRO ALTA

Mesa abatible. Patas de polipropileno reforzado con fibra de vidrio. Tubo de aluminio lacado. Reguladores de altura.

*Mesa dobrável. Pés de polipropileno reforçado com fibra de vidro. Tubo de alumínio lacado. Reguladores de altura.*

Folding table. Legs in fiber glass reinforced polypropylene. Laquered aluminium tube. Adjustable leveling feet.

*Table pliante. Piètement en polypropylène renforcé avec fibre de verre. Tube aluminium laqué. Régulateurs d' hauteur.*

### INFORMACION - INFORMAÇÃO INFORMATION

**60x60 - ø60**

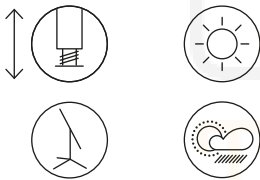

pesos/ballasts

### COLORES - CORES - COLOURS - COULEURS



**40QUA10**  
blanco - branco  
white - blanc



**40QUA11**  
antracita - anthracite



**40QUA13**  
taupe



**40QUA12**  
moca - mocha - moka

### MEDIDAS - MEASUREMENTS - MESURES

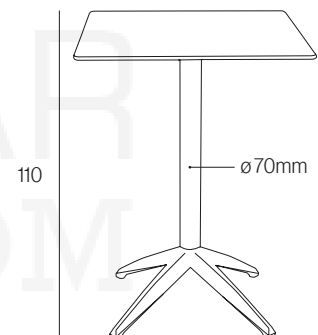

TABLEROS - TAMPOS - TOPS - PLATEAUX  
PAG.63

**COMPACT** INDORTEC  
ø60







ONE

Mesa apilable. Patas de polipropileno reforzado con fibra de vidrio. Inyección por gas.

*Mesa empilhável. Pés de polipropileno reforçado com fibra de vidro. Injeção por gás.*

Stackable table. Legs in fiber glass reinforced polypropylene. Gas injection.

*Table empilable. Piétement en polypropylène renforcé avec fibre de verre. Injection par gaz.*

INFORMACION - INFORMAÇÃO  
INFORMATION

60x60 - 70x70 - 80x80 - 60x80

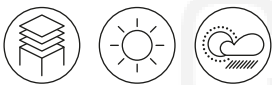

COLORES - CORES - COLOURS - COULEURS



**42ONE00**  
blanco - branco  
white - blanc



**42ONE01**  
antracita - anthracite



**42ONE02**  
taupe



**42ONE04**  
moca - mocha - moka



**42ONE03**  
cherry

TABLEROS - TAMPOS - TOPS - PLATEAUX  
PAG. 63

**COMPACT**

MEDIDAS - MEASUREMENTS - MESURES

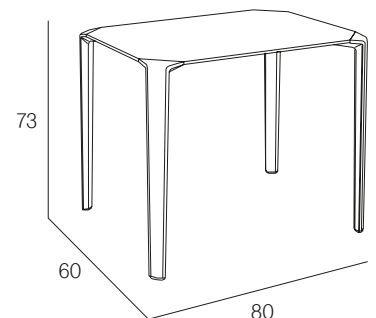
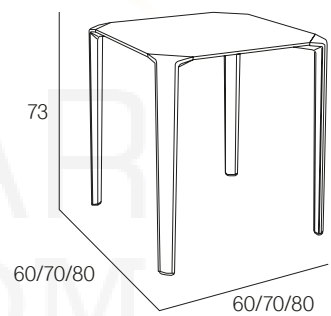





ONE

Mesa apilable. Patas de polipropileno reforzado con fibra de vidrio. Inyección por gás.

*Mesa empilhável. Pés de polipropileno reforçado com fibra de vidro. Injeção por gás.*

Stackable table. Legs in fiber glass reinforced polypropylene. Gas injection.

*Table empilable. Piétement en polypropylène renforcé avec fibre de verre. Injection par gaz.*

INFORMACION - INFORMAÇÃO  
INFORMATION

ø60 - ø70

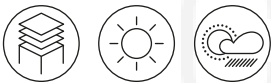

COLORES - CORES - COLOURS - COULEURS



**42ONE00**  
blanco - branco  
white - blanc



**42ONE01**  
antracita - anthracite



**42ONE02**  
taupe



**42ONE04**  
moca - mocha - moka



**42ONE03**  
cherry

MEDIDAS - MEASUREMENTS - MESURES

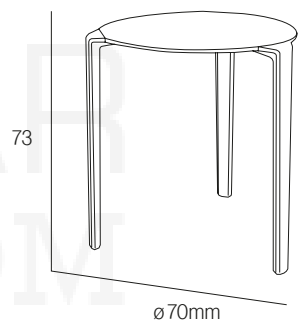

TABLEROS - TAMPOS - TOPS - PLATEAUX  
PAG. 63

**COMPACT**







## MONACO

Mesa apilable. Estructura de aluminio soldada y pintada. Reguladores de altura.

Mesa empilhável. Estrutura de alumínio soldada e pintada. Reguladores de altura.

Stackable table. Welded and painted aluminium frame. Adjustable leveling feet.

Table empilable. Structure en aluminium soudée et peinte. Régulateurs d'hauteur.

### INFORMACION - INFORMAÇÃO INFORMATION

**70x70 - 80x80**

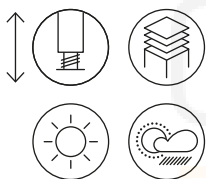

### COLORES - CORES - COULEURS - COULEURS

70x70



**42MON04**

blanco-branco-white-blanc



**42MON02**

negro-preto-black-noir



**42MON00**

gris-cinza-grey-gris



**42MON03**

óxido-rust-rouille

### COLORES - CORES - COULEURS - COULEURS

80x80



**42MON14**

blanco-branco-white-blanc



**42MON12**

negro-preto-black-noir



**42MON10**

gris-cinza-grey-gris



**42MON13**

óxido-rust-rouille

### MEDIDAS - MEASUREMENTS - MESURES

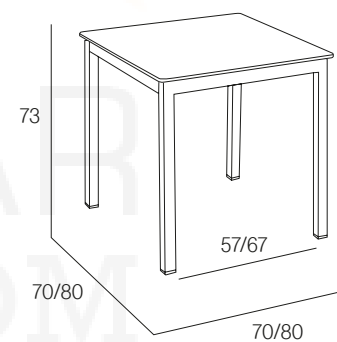

TABLEROS - TAMPOS - TOPS - PLATEAUX  
PAG. 63

**COMPACT**

NEW



### LOFT

Patas de aluminio lacado. Reguladores de altura.

*Pés de alumínio lacado. Reguladores de altura.*

Laquered aluminium legs. Adjustable leveling feet.

*Pieds aluminium laqué. Régulateurs d'hauteur.*

#### INFORMACION - INFORMAÇÃO INFORMATION

**70x70 - 80x80 - 90x90 - 120x80**

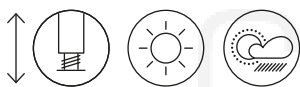

#### COLORES - CORES - COLOURS - COULEURS



**42LOF04**  
blanco - branco  
white - blanc

#### MEDIDAS - MEASUREMENTS - MESURES

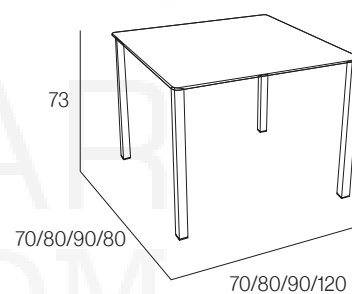

TABLEROS - TAMPOS - TOPS - PLATEAUX  
PAG. 63

**COMPACT** **INDORTEC**  
70x70 - 120x80





## MONACO

Mesa apilable. Estructura de aluminio soldada y pintada. Reguladores de altura.

Mesa empilhável. Estrutura de alumínio soldada e pintada. Reguladores de altura.

Stackable table. Welded and painted aluminium frame. Adjustable leveling feet.

Table empilable. Structure en aluminium soudée et peinte. Régulateurs d'hauteur.

### INFORMACION - INFORMAÇÃO INFORMATION

**60x60**

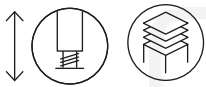

### COLORES - CORES - COLOURS - COULEURS



**42MON64**  
blanco - branco  
white - blanc



**42MON62**  
negro - preto  
black - noir



**42MON60**  
gris - cinza  
grey - gris



**42MON63**  
óxido - rust - rouille

### MEDIDAS - MEASUREMENTS - MESURES

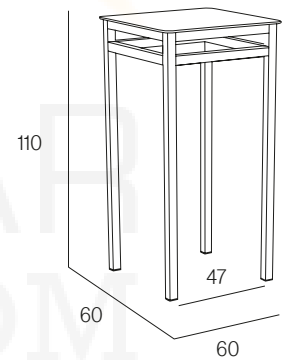

TABLEROS - TAMPOS - TOPS - PLATEAUX  
PAG. 63

**COMPACT**





KOS

Mesa abatible. Pata aluminio lacado. Reguladores de altura.

Mesa dobrável. Pé alumínio lacado. Reguladores de altura.

Folding table. Laquered aluminium leg. Adjustable leveling feet.

Table pliante. Pied aluminium laqué. Régulateurs d'hauteur.

INFORMACION - INFORMAÇÃO  
INFORMATION

60x60 - 70x70 - ø60 - ø70

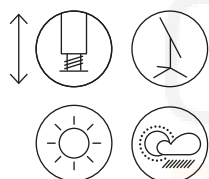

COLORES - CORES - COLOURS - COULEURS



**42KOS00**  
blanco - branco  
white - blanc



**42KOS01**  
taupe



**42KOS02**  
antracita - anthracite

NEW

MEDIDAS - MEASUREMENTS - MESURES

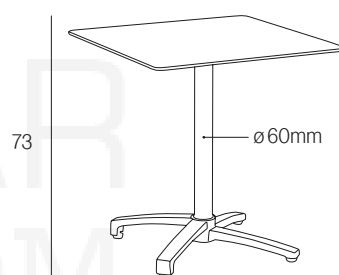

TABLEROS - TAMPOS - TOPS - PLATEAUX  
PAG.63

**COMPACT** **INDORTEC**  
ø60 - 70x70



NEW



### KOS DUO

Mesa abatible. Pata aluminio lacado. Reguladores de altura.

Mesa dobrável. Pé alumínio lacado. Reguladores de altura.

Folding table. Laquered aluminium leg. Adjustable leveling feet.

Table pliante. Pied aluminium laqué. Régulateurs d'hauteur.

#### INFORMACION - INFORMAÇÃO INFORMATION

120x80 - 120x70

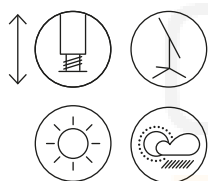

pesos/ballasts

#### COLORES - CORES - COLOURS - COULEURS



42KOS12  
antracita - anthracite

#### MEDIDAS - MEASUREMENTS - MESURES

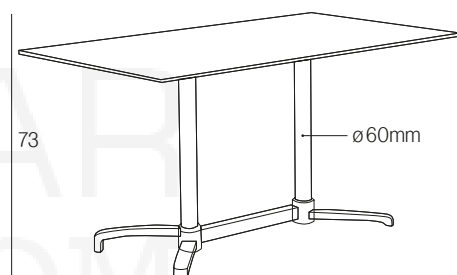

TABLEROS - TAMPOS - TOPS - PLATEAUX  
PAG.63

**COMPACT** INDORTEC  
120x80





## TREBOL

Mesa abatible. Pata acero lacado. Reguladores de altura.

*Mesa dobrável. Pé aço lacado. Reguladores de altura.*

Folding table. Laquered steel leg. Adjustable leveling feet.

*Table pliante. Pied acier laqué. Régulateurs d'hauteur.*

### INFORMACION - INFORMAÇÃO INFORMATION

**60x60 - 70x70 - ø60 - ø70**

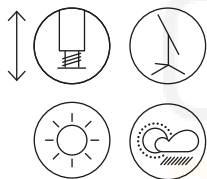

### COLORES - CORES - COLOURS - COULEURS



**42TRE00**  
blanco - branco  
white - blanc



**42TRE01**  
negro - preto  
black - noir

### MEDIDAS - MEASUREMENTS - MESURES

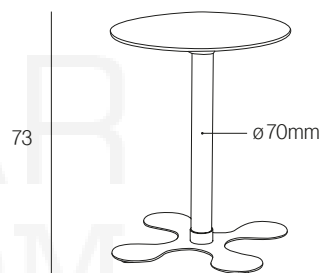

TABLEROS - TAMPOS - TOPS - PLATEAUX  
PAG. 63

**COMPACT**





# INDOORTEC



El tablero INDOORTEC (14mm) es una solución en fibra de madera de elevada densidad, especialmente pensada para ser utilizada en ambientes interiores de humedad alta. Se ofrece con un recubrimiento melamínico de gran resistencia con efecto natural de color roble.

*O tampo INDOORTEC (14mm) é uma solução em fibra de madeira de elevada densidade, especialmente pensada para ser utilizada em interiores de muita humidade. Oferece-se com um revestimento melamínico de grande resistência com efeito natural de cor carvalho.*

The INDOORTEC table top (14mm) is a high density wood fiber solution, especially thought to be used in high moisture interior environments. It is made up of a high resistant melamine cover, offering a natural oak colour effect.

*Le plateau INDOORTEC (14mm) est une solution en fibre de bois à haute densité, spécialement pensée pour être utilisée dans des espaces intérieurs de grande humidité. Il s'agit d'une option avec un revêtement en mélamine de grande résistance, qui offre un effet naturel de couleur chêne.*

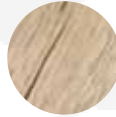

**092K10**

roble/carvalho/oak/chêne

## COMPACT

Tablero termolaminado compacto decorativo (10mm). Formado en la cara exterior por papel decorativo impregnado y en el interior por papel kraft impregnado con resinas termoestables. A este material se le aplica en la prensa temperatura y presión de forma simultánea para conseguir un tablero compacto de alta densidad.

*Tampo termolaminado compacto decorativo (10mm). A sua face exterior é formada por papel decorativo impregnado e o seu interior por papel kraft impregnado com resinas termoestáveis. O conjunto é prensado por meio de calor e alta pressão de forma simultânea para conseguir um tampo compacto de alta densidade.*

Decorative pressed laminated table top (10mm). Interior composed of thermostable resin kraft paper and surface lined with impregnated decorative paper. The compound is pressed simultaneously at high temperature and pressure to obtain a high density compacted table top.

*Plateau stratifié compact décoratif (10mm). Formé sur sa face extérieure par du papier décoratif imprégné et dans son intérieur par du papier kraft imprégné avec des résines thermostables. L'ensemble est ensuite pressé sous l'action de la chaleur et de la haute pression, simultanément, afin d'obtenir un plateau compact de haute densité.*

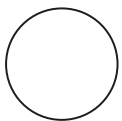

**010K00**

blanco/branco/  
white/blanc

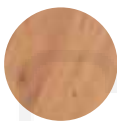

**011K00**

pino viejo/pinho velho/  
old pine/vieux pin



**090K00 \***

negro/preto/  
black/noir



**016K00**

stratos



**012K00**

wengue



**020K00**

taupe



**091K00**

antracita/  
anthracite\*



**092K00**

roble/carvalho/  
oak/chêne

NEW

TOLDOS.COM

Colores disponibles para mesa One - Cores disponíveis pra mesa One - Available colours for One table - Couleurs disponibles table One.

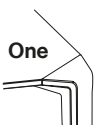

One

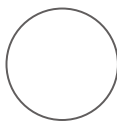

**010K00**

blanco/branco/  
white/blanc



**012K00**

wengue



**020K00**

taupe



**091K00**

antracita/anthracite\*

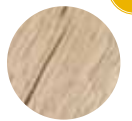

**092K00**

roble/carvalho/oak/  
chêne

NEW

\* Utilizar sólo en zonas sombreadas - Somente utilizar en áreas de sombra - For use in shadowed areas - À utiliser seulement en zones sombres.



The image shows an outdoor terrace area with several square tables and white plastic chairs. The tables have dark brown tops. There are two closed white patio umbrellas. The terrace is paved with grey stone tiles. In the background, there is a wall made of horizontal wooden slats. To the right, there are some bare tree branches with a few yellow leaves. The overall scene is set in a bright, sunny environment.

# TERRAZAS ESPLANADAS TERRACES TERRASSES 2017





# CUP



Sillón apilable. Polipropileno. Patas de aluminio pintado. /  
Cadeira empilhável. Polipropileno. Pés em alumínio pintado. /  
Stackable armchair. Polypropylene. Painted aluminium legs. /  
Fauteuil empilable. Polypropylène. Pieds en aluminium peint.

**CAY0102670001P1**

**45 x 45 x 3,5 + 2 cm**



**A 58 x B 50 x C 79 cm**



**MN-CUP02-010X00**

blanco | branco | white | blanc



**MN-CUP01-023X00**

óxido | rust | rouille

# OZONE



Sillón apilable. Polipropileno. Patas de aluminio pintado. /  
Cadeira empilhável. Polipropileno. Pés em alumínio pintado. /  
Stackable armchair. Polypropylene. Painted aluminium legs. /  
Fauteuil empilable. Polypropylène. Pieds en aluminium peint.

**CAY0102670001P1**

**45 x 45 x 3,5 + 2 cm**



**A 56 x B 54 x C 85 cm**



**MN-OZ003-010X00**

blanco | branco | white | blanc



**MN-OZ004-023X00**

óxido | rust | rouille



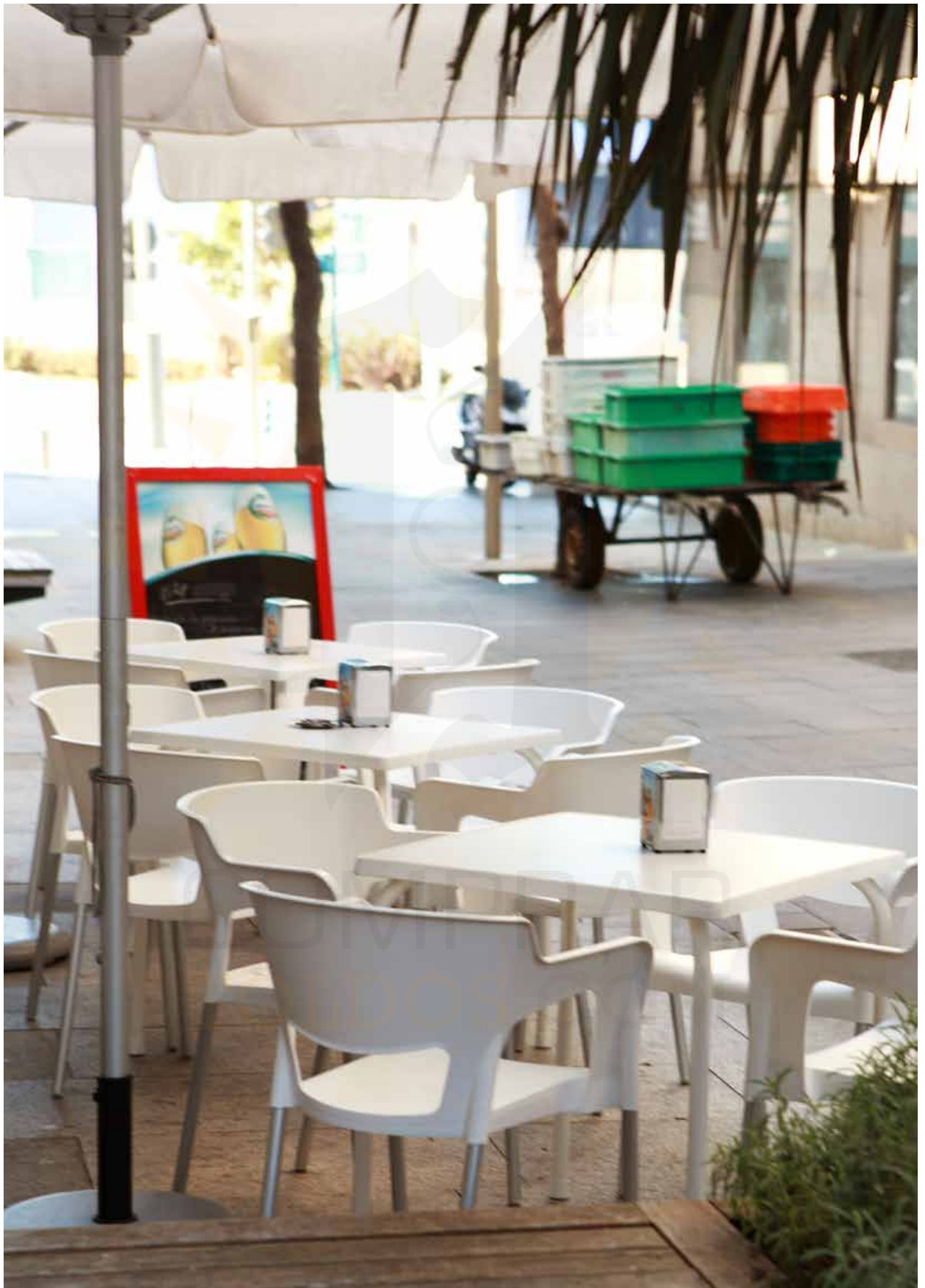



# OZONE

Sillón apilable. Polipropileno. Patas de aluminio. / Cadeira empilhável. Polipropileno. Pés em alumínio. / Stackable armchair. Polypropylene. Aluminium legs. / Fauteuil empilable. Polypropylène. Pieds en aluminium.



**CAY0102670001P1**

**45 x 45 x 3,5 + 2 cm**



**A 56 x B 54 x C 85 cm**



**MN-OZ001-090X00**  
negro | preto | black | noir



**MN-OZ001-010X00**  
blanco | branco | white | blanc



**MN-OZ001-040X00 \***  
rojo | vermelho | red | rouge



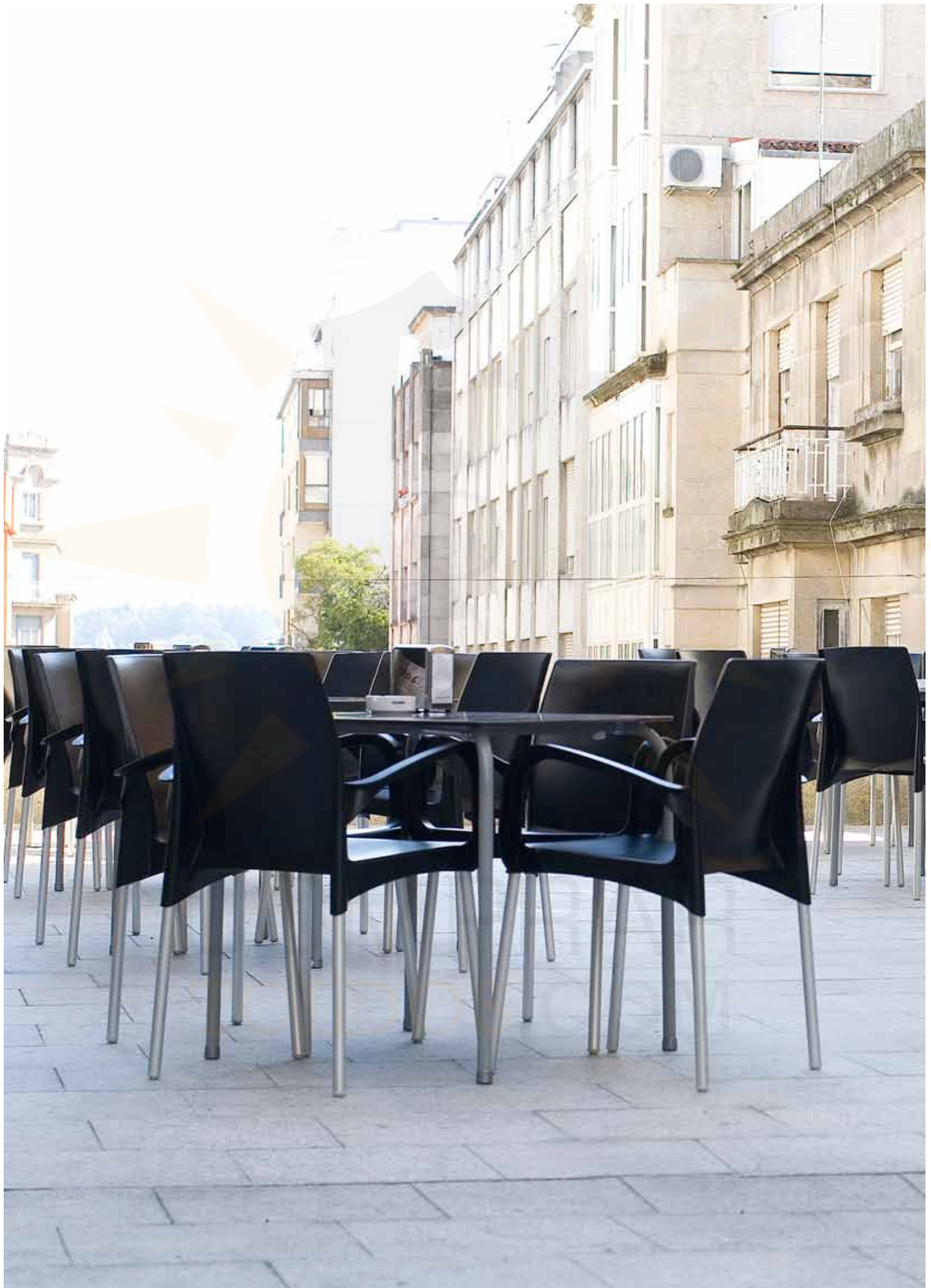



# BOWL

Sillón apilable. Polipropileno. Patas de aluminio. / Cadeira empilhável. Polipropileno. Pés em alumínio. / Stackable armchair. Polypropylene. Aluminium legs. / Fauteuil empilable. Polypropylène. Pieds en aluminium.

**CAY0102670001P1**

**45 x 45 x 3,5 + 2 cm**



**A 58 x B 53 x C 82 cm**



**MN-BOW00-090X00**  
negro | preto | black | noir



**MN-BOW00-010X00**  
blanco | branco | white | blanc



**MN-BOW00-040X00 \***  
rojo | vermelho | red | rouge



**MN-BOW00-050X00 \***  
verde | green | vert

Hasta fin de existencias/Limitado ao stock existente/ Up to end of stock/ Jusqu' à fin de stocks



# CUP

Sillón apilable. Polipropileno. Patas de aluminio. / Cadeira empilhável. Polipropileno. Pés em alumínio. / Stackable armchair. Polypropylene. Aluminium legs. / Fauteuil empilable. Polypropylène. Pieds en aluminium.

**CAY0102670001P1**

**45 x 45 x 3,5 + 2 cm**



**A 58 x B 50 x C 79 cm**



**MN-CUP00-090X00**  
negro | preto | black | noir



**MN-CUP00-010X00**  
blanco | branco | white | blanc



**MN-CUP00-040X00**  
rojo | vermelho | red | rouge



**MN-CUP00-050X00**  
verde | green | vert





# ARUBA



Sillón apilable. Aluminio y ratan plano. / *Cadeira empilhável. Alumínio e ratan plano.* / Stackable armchair. Aluminium and flat rattan. / *Fauteuil empilable. Aluminium et rattan plat.*

A 56 x B 55 x C 79,55 cm

T. ø 28 x 1,8 mm



● MN-ARU00-090R30  
negro | preto | black | noir

● MN-ARU00-010R30  
blanco | branco | white | blanc

● MN-ARU00-045R30 \*  
gris | cinza | grey | gris

● MN-ARU00-050R30 \*  
verde | green | vert

● MN-ARU00-020R30  
chocolate | chocolat

# TORALLA



Sillón apilable. Aluminio doble tubo y ratan redondo. Tornillería acero inox. / *Cadeira empilhável. Alumínio duplo tubo e ratan redondo. Parafusos aço inox.* / Stackable armchair. Double tube aluminium and round rattan. Stainless steel screws. / *Fauteuil empilable. Aluminium double tube et rattan rond. Visserie acier inox.*

A 55 x B 61 x C 80 cm

T. ø 25 x 1,5 mm



● MN-TOR00-090R10  
negro | preto | black | noir

● MN-TOR00-010R10  
blanco | branco | white | blanc

● MN-TOR00-020R10  
chocolate | chocolat

● MN-TOR00-060R10  
café | coffee

Hasta fin de existencias/Limitado ao stock existente/ Up to end of stock/ Jusqu' à fin de stocks







# BORNEO



**A 56 x B 56,5 x C 74 cm**

**T. ø 25 x 2 mm**



**MN-BOR00-090R10**  
negro | preto | black | noir

**MN-BOR00-010R10**  
blanco | branco | white | blanc

**MN-BOR00-020R10**  
chocolate | chocolat

**MN-BOR00-060R10**  
café | coffee



# AZORES



Sillón apilable. Aluminio. 7 lamas. Tornillería acero inox. /  
Cadeira empilhável. Alumínio. 7 ripas. Parafusos aço inox. /  
Stackable armchair. Aluminium. 7 slats. Stainless steel screws.  
/ Fauteuil empilable. Aluminium. 7 lamelles. Visserie acier inox.

**CXE0106620110P1**

**82 x 45 x 3,5 cm**



**A 50 x B 55 x C 79 cm**

**T. ø 25 x 2 mm**



**MN-AZ002 \***

aluminio | alumínio | aluminium

# VICTORIA



Sillón apilable. Aluminio. Respaldo 2 lamas. Tornillería acero  
inox. / Cadeira empilhável. Alumínio. Encosto 2 ripas. Parafusos  
aço inox. / Stackable armchair. Aluminium. 2 slats in backrest.  
Stainless steel screws. / Fauteuil empilable. Aluminium. Dossier  
2 lamelles. Visserie acier inox.

**A 56 x B 60 x C 75 cm**

**T. ø 25 x 2 mm**



**MN-VIC00\***

aluminio | alumínio | aluminium

Hasta fin de existencias/Limitado ao stock existente/ Up to end of stock/ Jusqu'à fin de stocks

# OZONE



Taburete apilable. Polipropileno. Patas de acero lacado. / Banco alto empilhável. Polipropileno. Pés em aço lacado. / Stackable stool. Polypropylene. Laquered steel legs. / Tabouret empilable. Polypropylène. Pieds en acier laqué.

A 57 x B 77 x C 115 x D 79 cm



● **MT-OZ000-090X00**  
negro | preto | black | noir

● **MT-OZ000-010X00**  
blanco | branco | white | blanc

● **MT-OZ000-040X00 \***  
rojo | vermelho | red | rouge

# BORNEO



Taburete apilable. Aluminio y ratán redondo. Tornillería acero inox. / Banco alto empilhável. Alumínio e ratan redondo. Parafusos aço inox. / Stackable stool. Aluminium and round rattan. Stainless steel screws. / Tabouret empilable. Aluminium et rattan rond. Visserie acier

A 47 x B 55 x C 96 x D 79 cm

T. ø 25 x 2 mm



● **MT-BOR00-090R10**  
negro | preto | black | noir

● **MT-BOR00-090R10**  
blanco | branco | white | blanc

● **MT-BOR00-020R10 \***  
chocolate | chocolat

● **MT-BOR00-050R10 \***  
verde | green | vert

● **MT-BOR00-045R10 \***  
gris | cinza | grey | gris

● **MT-BOR00-060R10**  
café | coffee

Hasta fin de existencias/Limitado ao stock existente/ Up to end of stock/ Jusqu' à fin de stocks



# AZORES



Taburete apilable. Aluminio. Tornillería acero inox. / Banco alto empilhável. Alumínio. Parafusos aço inox. / Stackable stool. Aluminium. Stainless steel screws. / Tabouret empilable. Aluminium. Visserie acier inox.

**A 47 x B 55 x C 96 x D 78 cm**

**T. ø 25 x 2 mm**



● **MT-AZ000 \***

aluminio | alumínio | aluminium

Hasta fin de existencias/Limitado ao stock existente/ Up to end of stock/ Jusqu' à fin de stocks



# VENUS

Mesa abatible. Epoxi blanco-gris. / Mesa dobrável. Epoxi branco-cinza. / Folding table. White-grey epoxy. / Table pliante. Epoxy blanc-gris.



○ **40VEN00**  
blanco | branco | white | blanc

● **40VEN01**  
gris | cinza | grey | gris

ø60/60X60/ø70/70X70

ø60x73 cm - A60xB60xC73 cm - T. ø30 mm

ø70x73 cm - A70xB70xC73 cm - T. ø30 mm



COMPACT



WERZALIT

# VENUS HIGH

Mesa alta abatible. Epoxi gris. / Mesa alta dobrável. Epoxi cinza. / High folding table. Grey epoxy. / Table haute pliante. Epoxy gris.

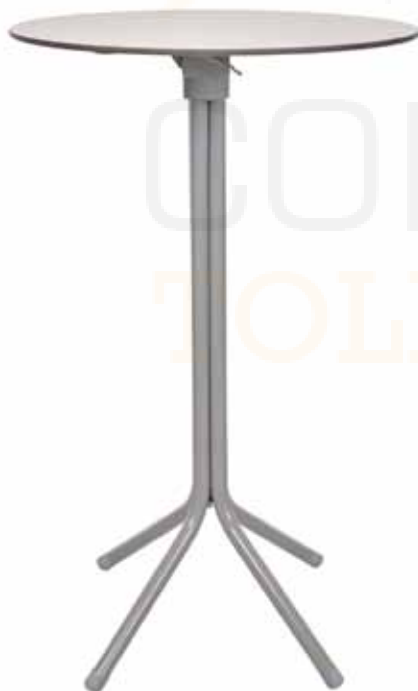

● **40VEN11**  
gris | cinza | grey | gris

ø60/60X60

ø60x112 cm - A60xB60xC 112 cm - T. ø30 mm



COMPACT



WERZALIT

# TAURO

Mesa apilable. Aluminio. Tubo sencillo. / *Mesa empilhável. Alumínio. Tubo simples.* / Stackable table. Aluminium. Single tube. / *Table empilable. Aluminium. Un seul tube.*



42TAU00 - 60X60

**A 60 x B 60 x C 73 cm**  
**T. ø 30 x 1,5 mm**



COMPACT



WERZALIT



INOX

# ACUARIO

Mesa apilable. Aluminio. Tubo sencillo. / *Mesa empilhável. Alumínio. Tubo simples.* / Stackable table. Aluminium. Single tube. / *Table empilable. Aluminium. Un seul tube.*



42ACU00 - 70X70

**A 70 x B 70 x C 73 cm**  
**T. ø 28 x 1,8 mm**



COMPACT



WERZALIT

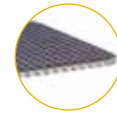

INOX

◀ || +SPACE || ▶



# PISCIS

Mesa apilable. Aluminio. Tubo doble. / *Mesa empilhável. Alumínio. Tubo duplo.* / Stackable table. Aluminium. Double tube. / *Table empilable. Aluminium. Double tube.*



42PIS00 - 70X70

**A 70 x B 70 x C 73 cm**

**T. ø 25 x 1,5 mm**



COMPACT



WERZALIT



INOX



# GEMINIS

Mesa apilable. Aluminio. Tubo doble. / *Mesa empilhável. Alumínio. Tubo duplo.* / Stackable table. Aluminium. Double tube. / *Table empilable. Aluminium. Double tube.*



42GEM00 - 80X80

**A 80 x B 80 x C 73 cm**

**T. ø 25 x 1,5 mm**



COMPACT



WERZALIT

# SIX

Mesa apilable. Inox. Tubo sencillo. / *Mesa empilhável. Inox. Tubo simples.* / Stackable table. Stainless steel. Single tube. / *Table empilable. Inox. Un seul tube.*



40SIX00 - 70X70

**A 70 x B 70 x C 73 cm**

**T. ø 28 x 1,5 mm**



COMPACT



WERZALIT

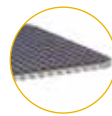

INOX

# BRODAS

Mesa apilable. Epoxi blanco. Tubo sencillo. / *Mesa empilhável. Epoxi branco. Tubo simples.* / Stackable table. White epoxy. Single tube. / *Table empilable. Époxy blanc. Un seul tube.*



40BRO00 - 70X70 - ø80

ø80x73 cm  
A 70 x B 70 x C 73 cm  
T. ø 30 mm



COMPACT



WERZALIT (R80)



POLYPROPYLENE

# GRODAS

Mesa apilable. Epoxi gris. Tubo sencillo. / *Mesa empilhável. Epoxi cinza. Tubo simples.* / Stackable table. Grey epoxy. Single tube. / *Table empilable. Époxy gris. Un seul tube.*



40GRO00 - 70X70 - ø80

ø80x73 cm  
A 70 x B 70 x C 73 cm  
T. ø 30 mm



COMPACT



WERZALIT (R80)



POLYPROPYLENE



# ORODAS

Mesa apilable. Epoxi óxido. Tubo sencillo. / Mesa empilhável. Epoxi óxido. Tubo simples. / Stackable table. Rust epoxy. Single tube. / Table empilable. Époxy oxyde. Un seul tube.



40OR000 - 70X70 - ø80

ø80x73 cm  
A 70 x B 70 x C 73 cm  
T. ø 30 mm



COMPACT



WERZALIT (R80)



POLYPROPYLENE

# NRODAS

Mesa apilable. Epoxi negro. Tubo sencillo. / Mesa empilhável. Epoxi preto. Tubo simples. / Stackable table. Black epoxy. Single tube. / Table empilable. Époxy noir. Un seul tube.



40NR000 - 70X70 - ø80

ø80x73 cm  
A 70 x B 70 x C 73 cm  
T. ø 30 mm



COMPACT



WERZALIT (R80)

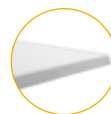

POLYPROPYLENE

# GMIKONOS

Mesa apilable. Epoxi gris. Tubo sencillo. / Mesa empilhável. Epoxi cinza. Tubo simples. / Stackable table. Grey epoxy. Single tube. / Table empilable. Époxy gris. Un seul tube.



40GMI00 - 80X80

**A 80 x B 80 x C 73 cm**  
**T. ø 30 mm**



COMPACT



WERZALIT

# BMIKONOS

Mesa apilable. Epoxi blanco. Tubo sencillo. / Mesa empilhável. Epoxi branco. Tubo simples. / Stackable table. White epoxy. Single tube. / Table empilable. Époxy blanc. Un seul tube.



40BMI00 - 80X80

**A 80 x B 80 x C 73 cm**  
**T. ø 30 mm**



COMPACT



WERZALIT

# AXIS

Mesa de aluminio con pie central. / Mesa de aluminio con pé central. / Aluminium table with central leg. / Table de aluminium avec pied central.



42AXI00 -  $\varnothing 60/60 \times 60/\varnothing 70/70 \times 70$

$\varnothing 60 \times 73$  cm - A60xB60xC73 cm - T.  $\varnothing 60$  mm  
 $\varnothing 70 \times 73$  cm - A70xB70xC73 cm - T.  $\varnothing 60$  mm



COMPACT



WERZALIT

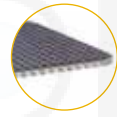

INOX

# LINUX

Mesa Alta. Aluminio. / Mesa Alta. Alumínio. / High table. Aluminium. / Table Haute. Aluminium.



42LIN00 -  $\varnothing 60/60 \times 60/\varnothing 70/70 \times 70$

$\varnothing 60 \times 112$  cm - A60xB60xC 112 cm - T.  $\varnothing 60$  mm  
 $\varnothing 70 \times 112$  cm - A70xB70xC112 cm - T.  $\varnothing 60$  mm



COMPACT



WERZALIT

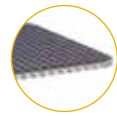

INOX



# OLEFIN

NUEVO TEJIDO - NOVO TEJIDO - NEW FABRIC - NOUVEUA TISSU

▪ **ALTA SOLIDEZ DE LOS COLORES A LA RADICACIÓN UV.** Se trata de un tejido fabricado con hilo de polipropileno que ha sido tintado en masa, en su proceso inicial. Esto le otorga una gran resistencia a la luz solar ya que el color queda fijado en el hilo del tejido con mayor intensidad que en otros procesos.

▪ **CERTIFICACIÓN UV STANDARD 801** con la puntuación UPF 80, que garantiza la protección de la piel de los efectos nocivos de los rayos UV.

▪ **REPELENTE AL AGUA - RESISTENTE A LAS MANCHAS - 100% RECICLABLE**

▪ **ALTA RESISTÊNCIA DAS CORES FACE À RADIAÇÃO UV.** Sendo um tecido fabricado com fio em polipropileno tingido em massa no seu processo inicial, esta característica confere-lhe uma maior resistência à luz solar o que se deve essencialmente ao facto de a cor permanecer fixada ao fio com maior intensidade do que em outros processos de pigmentação.

▪ **CERTIFICAÇÃO UV STANDARD 801** com factor de proteção UPF 80, que garante a proteção da pele dos efeitos nocivos dos raios UV.

▪ **REPELENTE À ÁGUA - ANTI-MANCHAS - 100% RECICLÁVEL**

▪ **HIGH RESISTANCE OF COLOURS TO UV RADIATION.** The fabric is made from polypropylene fabric mass-dyed during the initial process. This provides high resistance to sunlight because the colour is set in the thread of the fabric more intensely than in other processes.

▪ **UV STANDARD 801 rating UPF80,** that guarantees skin protection against nocive effects of UV rays on the skin.

▪ **WATER REPELLENT - STAIN RESISTANCE - 100% RECYCLABLE**







▪ **HAUTE RÉSIDENCE DE COULEURS FACE À LA RADIATION SOLAIRE.** Il s'agit ici d'une toile fabriquée à partir d'un fil en polypropylène qui a été teinté en masse, depuis son processus initial. Ceci lui confère une haute résistance à la lumière solaire, étant donné que la teinte reste fixée sur le fil avec une plus grande intensité en comparaison avec d'autres processus de pigmentation.

▪ **CERTIFICATION UV STANDARD 801** avec punctuation UPF 80, qui donne garantie de la protection de la peau des effets nocifs des rayons UV.

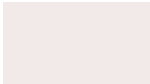
▪ **REPELENTE À L'EAU - RÉSISTENT AUX TACHES - 100% RECYCLABLE**



## COLORES - CORES - COLOURS - COULEURS - 190gr.

 <b>103010</b> arena - sand	 <b>102010</b> negro - preto black - noir	 <b>101010</b> taupe	 <b>110010</b> gris - cinza grey	 <b>109010</b> moka	 <b>108010</b> burdeos - burgundy bordeaux
 <b>111010</b> rojo - vermelho red - rouge	 <b>104010</b> amarillo - amarelo yellow - jaune	 <b>107010</b> crema - cream crème	 <b>105010</b> azul - blue bleu	 <b>106010</b> verde - green vert	

## COLORES - CORES - COLOURS - COULEURS - 250gr.

 <b>203010</b> arena - sand	 <b>202010</b> negro - preto black - noir	 <b>201010</b> taupe	 <b>010P11</b> blanco - branco white - blanc
--	---	---	--

## POLYESTER-WATER REPELLENT - 190g



Consultar tarifas parasoles - Consultar tabela de preços guarda-sóis - Please see parasols price list - Consulter tarifs parasols

SPAIN  
info@ezepeleta.com  
tel. +34 986 293 922

PORTUGAL  
ezepeleta.portugal@ezepeleta.com  
tel. +351 251 79 62 55

MEXICO  
ezepeleta.mexico@ezepeleta.com  
tel. +52 55 5520 2919  
tel. +52 55 5520 5909

FRANCE  
france@ezepeleta.com  
tel. +34 986 293 922

EXPORT  
export@ezepeleta.com  
tel. +34 986 293 922

Ezepeleta se reserva el derecho a realizar modificaciones técnicas en los productos de este catálogo. A Ezepeleta reserva-se o direito de realizar qualquer alteração técnica nos produtos descritos neste catálogo. Ezepeleta reserves the right to change the technical characteristics and specifications of the product in this catalog. Ezepeleta se réserve le droit de réaliser des modifications techniques sur les produits décrits sur ce catalogue.

KEEP THE  
DISTANCE

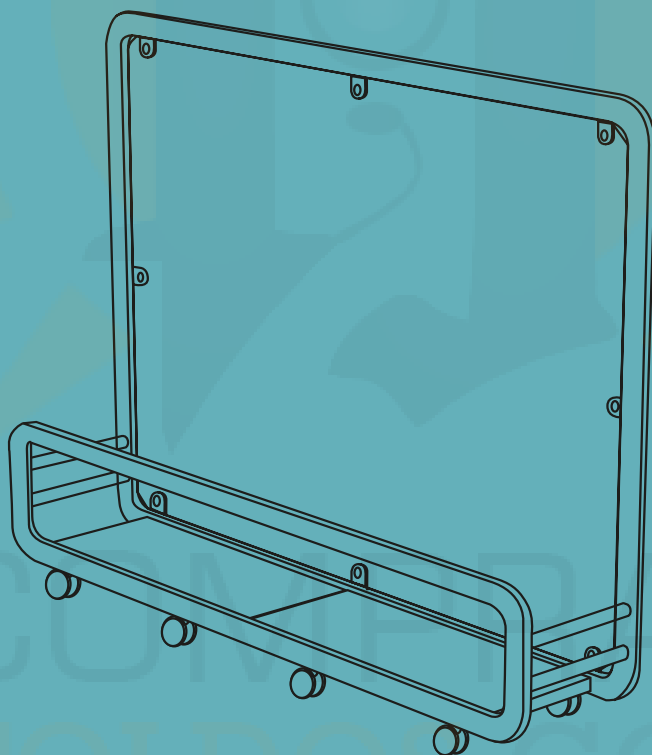

Separadores - *Divider module* - Module séparateur

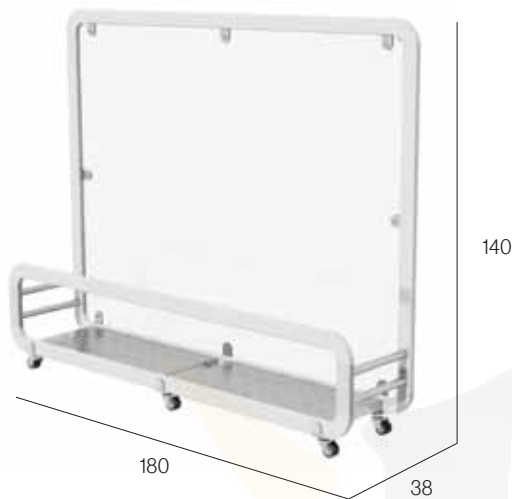

## SIENA MAXI

Módulo separador. Aluminio lacado y anodizado. Tornillería acero inox. Bandeja. 6 Ruedas (3 con freno). Conexiones en poliamida con fibra de vidrio.

*Módulo separador. Aluminio lacado e anodizado. Acessórios em aço inox. Bandeja. 6 Rodas (3 com travão). Conexões em poliamida com fibra de vidro.*

Divider module. Lacquered and anodized aluminium. Stainless steel hardware. Plate. 6 Wheels (3 with brake). Polyamide with fiberglass connecting pieces.

*Module séparateur. Aluminium laqué et anodisé. Visserie en acier inox. Plateau. 6 Roues (3 avec frein). Pièce de connection en polyamide avec fibre de verre.*



Negro - Preto - Black - Noir

### MO-MSIE05

(Metacrilato, Metacrilato, Methacrylate, Methacrylate)

### MO-VO10SIE05

(Tejido Olefin con ventana, Tecido Olefin com janela, Olefin fabric with window, Tissu Olefin avec fenêtre)

### MO-VP11SIE05

(Tejido Poliester con ventana, Tecido Poliester com janela, Polyester fabric with window, Tissu Poliester avec fenêtre)



blanco - branco - white - blanc

### MO-MSIE051B

(Metacrilato, Metacrilato, Methacrylate, Methacrylate)

### MO-VO10SIE05B

(Tejido Olefin con ventana, Tecido Olefin com janela, Olefin fabric with window, Tissu Olefin avec fenêtre)

### MO-VP11SIE05B

(Tejido Poliester con ventana, Tecido Poliester com janela, Polyester fabric with window, Tissu Poliester avec fenêtre)

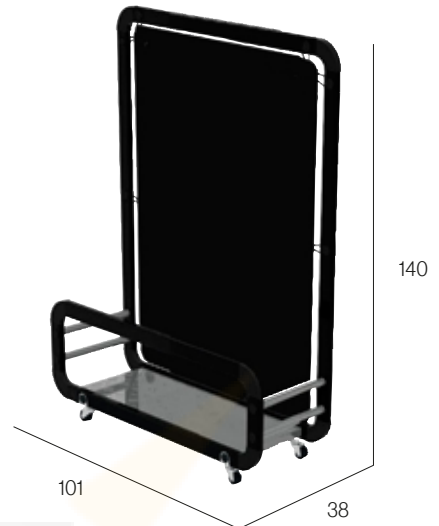

## SIENA MINI

Módulo separador. Aluminio lacado y anodizado. Tornillería acero inox. Bandeja. 4 Ruedas (2 con freno). Conexiones en poliamida con fibra de vidrio.

*Módulo separador. Aluminio lacado e anodizado. Acessórios em aço inox. Bandeja. 4 Rodas (2 com travão). Conexões em poliamida com fibra de vidro.*

Divider module. Lacquered and anodized aluminium. Stainless steel hardware. Plate. 4 Wheels (2 with brake). Polyamide with fiberglass connecting pieces.

*Module séparateur. Aluminium laqué et anodisé. Visserie en acier inox. Plateau. 4 Roues (2 avec frein). Pièce de connection en polyamide avec fibre de verre.*



Negro - Preto - Black - Noir

### MO-MSIE06

(Metacrilato, Metacrilato, Methacrylate, Methacrylate)

### MO-VO10SIE06B

(Tejido Olefin con ventana, Tecido Olefin com janela, Olefin fabric with window, Tissu Olefin avec fenêtre)

### MO-VP11SIE06B

(Tejido Poliester con ventana, Tecido Poliester com janela, Polyester fabric with window, Tissu Poliester avec fenêtre)



blanco - branco - white - blanc

### MO-MSIE061B

(Metacrilato, Metacrilato, Methacrylate, Methacrylate)

### MO-VO10SIE06B

(Tejido Olefin con ventana, Tecido Olefin com janela, Olefin fabric with window, Tissu Olefin avec fenêtre)

### MO-VP11SIE06B

(Tejido Poliester con ventana, Tecido Poliester com janela, Polyester fabric with window, Tissu Poliester avec fenêtre)



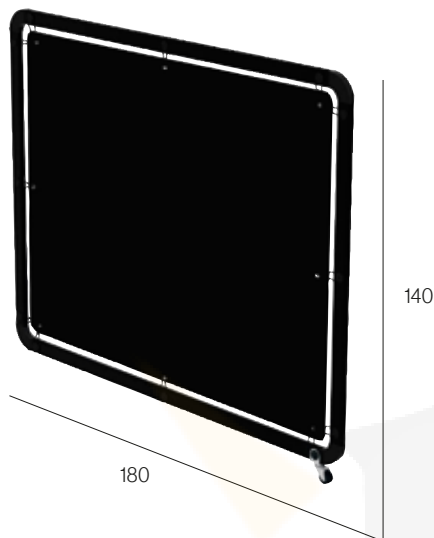

## SIENA MAXI

Panel separador. Aluminio lacado y anodizado. Tornillería acero inox. 1 rueda con freno. Conexiones en poliamida con fibra de vidrio.

*Painel separador. Alumínio lacado e anodizado. Acessórios em aço inox. 1 roda com travão. Conexões em poliamida com fibra de vidro.*

Divider panel. Lacquered and anodized aluminium. Stainless steel hardware. 1 wheel with brake. Polyamide with fiberglass connecting pieces.

*Panneau séparateur. Aluminium laqué et anodisé. Visserie en acier inox. 1 roue avec frein. Pièce de connection en polyamide avec fibre de verre.*



Negro - Preto - Black - Noir

### MO-MSIE03

(Metacrilato, Metacrilato, Methacrylate, Methacrylate)

### MO-VO10SIE03

(Tejido Olefin con ventana, Tecido Olefin com janela, Olefin fabric with window, Tissu Olefin avec fenêtre)

### MO-VP11SIE03

(Tejido Poliester con ventana, Tecido Poliester com janela, Polyester fabric with window, Tissu Poliester avec fenêtre)



blanco - branco - white - blanc

### MO-MSIE031B

(Metacrilato, Metacrilato, Methacrylate, Methacrylate)

### MO-VO10SIE03B

(Tejido Olefin con ventana, Tecido Olefin com janela, Olefin fabric with window, Tissu Olefin avec fenêtre)

### MO-VP11SIE03B

(Tejido Poliester con ventana, Tecido Poliester com janela, Polyester fabric with window, Tissu Poliester avec fenêtre)



## SIENA MINI

Panel separador. Aluminio lacado y anodizado. Tornillería acero inox. 1 rueda con freno. Conexiones en poliamida con fibra de vidrio.

*Painel separador. Alumínio lacado e anodizado. Acessórios em aço inox. 1 roda com travão. Conexões em poliamida com fibra de vidro.*

Divider panel. Lacquered and anodized aluminium. Stainless steel hardware. 1 wheel with brake. Polyamide with fiberglass connecting pieces.

*Panneau séparateur. Aluminium laqué et anodisé. Visserie en acier inox. 1 roue avec frein. Pièce de connection en polyamide avec fibre de verre.*



Negro - Preto - Black - Noir

### MO-MSIE04

(Metacrilato, Metacrilato, Methacrylate, Methacrylate)

### MO-VO10SIE04

(Tejido Olefin con ventana, Tecido Olefin com janela, Olefin fabric with window, Tissu Olefin avec fenêtre)

### MO-VP10SIE04

(Tejido Poliester con ventana, Tecido Poliester com janela, Polyester fabric with window, Tissu Poliester avec fenêtre)



blanco - branco - white - blanc

### MO-MSIE041B

(Metacrilato, Metacrilato, Methacrylate, Methacrylate)

### MO-VO10SIE04B

(Tejido Olefin con ventana, Tecido Olefin com janela, Olefin fabric with window, Tissu Olefin avec fenêtre)

### MO-VP11SIE04B

(Tejido Poliester con ventana, Tecido Poliester com janela, Polyester fabric with window, Tissu Poliester avec fenêtre)

ACCESORIOS - ACESSÓRIOS - ACCESSORIES - ACCESSOIRES



**MO-SIE41**

Rueda con freno - roda com travão - wheels with brake - roue avec frein.



● **MO-SIE52** - ○ **MO-SIE52B**  
Pernio para pared - dobradiça para parede - wall fitting - joint flexible pour mur.



● **52026** - ○ **52026B**  
Pernio individual - dobradiça individual - individual fittings - joint flexible individuel.



● **MO-JAR00** - ○ **MO-JAR01**  
Jardinera - jardineira - flowerpot - jardinière  
75x28x26 cm.



**MO-SIE90 (mini) - MO-SIE91 (maxi)**  
Vinilo decorativo - vinilo decorativo - decorative Vinyl - vinil decoratif.





## SIENA

Carro camarera. Aluminio lacado y anodizado. Tornillería acero inox lacada. Conexiones en poliamida con fibra de vidrio. Metacrilato. Compacto.

*Carro serviço de mesa. Alumínio lacado e anodizado. Acessórios em aço inox lacado. Conexões em poliamida com fibra de vidro. Metacrilato. Compacto.*

Waiter's car. Lacquered and anodized aluminium. Lacquered stainless steel screws. Polyamide with fiberglass connecting pieces. Methacrylate. Compact.

*Voiture service de table. Aluminium laqué et anodisé. Visserie en acier inox laqué. Connexions en polyamide avec fibre de verre. Methacrylate. Compact.*



Negro - Preto - Black - Noir  
**MO-SIE32**



blanco - branco - white - blanc  
**MO-SIE32B**

**COMPACT**



## MAUI

Separador de ambiente madera de pino y metacrilato.

*Separador de ambiente madeira de pinho e metacrilato.*

Pine wood and methacrylate Outdoor space divider.

*Séparateur d'ambiance en pin et méthacrylate.*



**MO-MAU00**  
250x160



**MO-MAU01**  
200x160

\*consultar acabados/consultar acabamentos/look up finishings/consulter confections

