



PERGO-SUN 80
siplano 



Características y aplicaciones



Sistema con aplicación en el montaje de toldos de dimensiones grandes a las que, además, queremos darles un toque de elegancia y belleza.

Este sistema solo puede ser montado con perfil de 80x40 y guías de 80x40x2.

Como el modelo estructura 80x40, podremos llegar a la línea que deseemos, aumentando las piezas y perfiles necesarios.

Dimensiones máximas: 5m de línea y 5 m de salida con dos guías.

Este modelo puede ser motorizado.

Perfiles fabricados con aluminio extrusionado (UNE, L-337).

Accesorios fabricados en aluminio.

Characteristics and applications



A system that can be used for large sized awning assemblies and for adding a touch of elegance and beauty.

This system can only be mounted with profiles 80x40 and guides 80x40x2.

As with the 80x40 model, we can reach any line needed by increasing the parts and profiles needed.

Every maximum length is allowed by increasing pieces and profiles as necessary.

Maximum measurements: 5 meters line by 5 meters projection with 2 guides.

This type of awning can be motorized.

Profiles made of extruded aluminium (UNE L-337).

Accessories made of aluminium.

Caractéristiques et les usages



Système applicable dans le montage de stores de grandes dimensions et auquel nous voulons donner en plus une touche d'élégance et de beauté.

Ce système peut seulement être monté avec un profil de 80x40 et des glissières de 80x40x2.

Comme le modèle structure 80x40, nous pourrions arriver à la ligne que nous souhaitons, en augmentant les pièces et les profils nécessaires.

Mesures maximales: 5 mètres de largeur sur 5 mètres d'avancée avec 2 rails de guidage.

Ce modèle peut être motorisé.

Profils fabriqués en aluminium extrudé (UNE, L-337).

Accessoires fabriqués en aluminium.

Eigenschaften und Anwendungen



System für die Montage von großen Markisen, denen wir außerdem einen Hauch von Eleganz und Schönheit geben wollen.

Dieses System kann nur mit 80x40 Profil und 80x40x2 Führungen montiert werden, womit wir die Linie erreichen, die wir wünschen, indem wir die nötigen Teile und Profile aufstocken.

Höchstmaße: Linie 5 x 5 Meter Ausladung mit 2 Führungen.

Dieses Modell kann motorisiert werden.

Profile hergestellt mit extrudiertem Aluminium (UNE, L-337).

Zubehör hergestellt aus Aluminium.

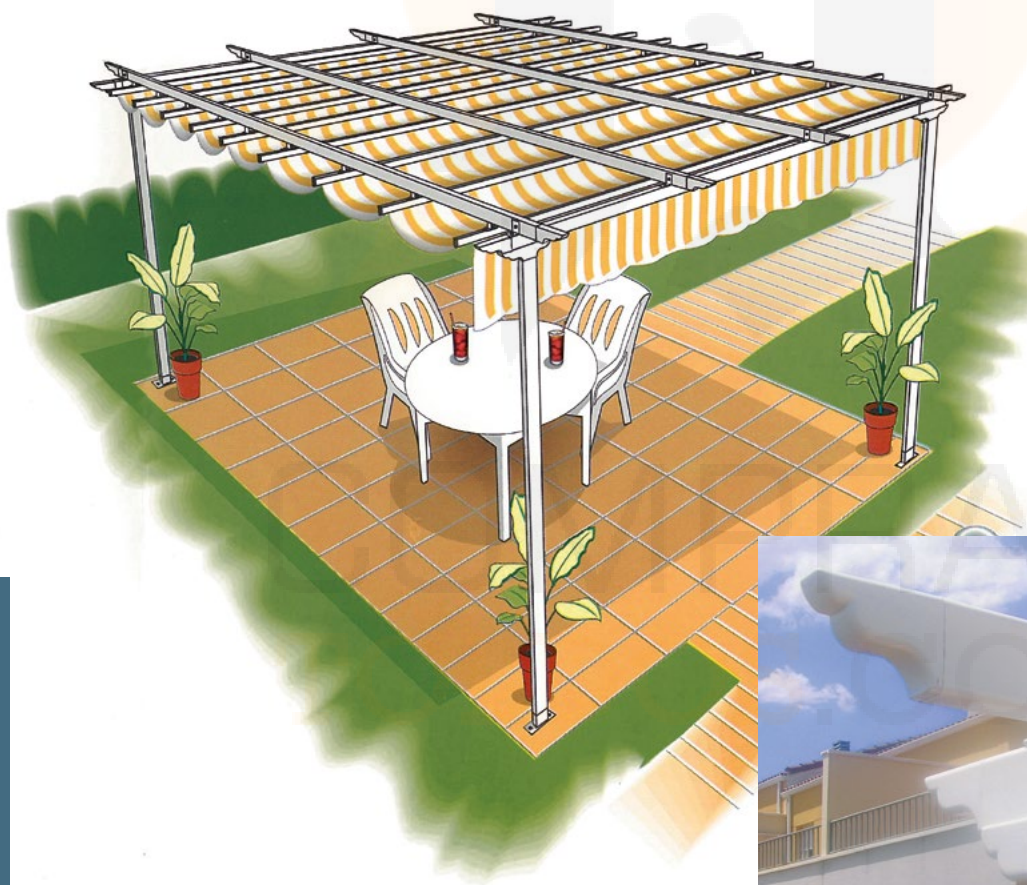



Ref.: 1305
 Guía Larguero 80x40x2
 Beam guide 80x40x2
 Rail de guidage Traverse 80x40x2
 Holmführung 80x40x2



Ref.: 1300
 Perfil 80x40x2
 Profile 80x40x2
 Profilé 80x40x2
 Profil 80x40x2



Ref.: 1310
 Guía 80x40x2
 Guide 80x40x2
 Glissière 80x40x2
 Führung 80x40x2



Ref.: 1310
 Guía 40x40
 Guide 40x40
 Glissière 40x40
 Führung 40x40



Ref.: 110300
 Acoplamiento Frontal Pecho Paloma
 Corbel wall coupling
 Assemblage Frontal Finition arrondie
 Frontalverbindung Zierleiste



Ref.: 110400
 Pecho Paloma Capitel Aluminio
 Aluminium double corbel bracket terminal
 Finition arrondie Chapiteau Aluminium
 Kapitell Zierleiste Aluminium



Ref.: 110200
 Pecho Paloma Terminal Aluminio
 Aluminium corbel bracket terminal
 Griff Finition arrondie Aluminium
 Terminal Zierleiste Aluminium



Ref.: 106100
 Soporte Guía 80x40 Inyección Aluminio
 Aluminium Injection Support Guide 80x40
 Support Rail de guidage 80x40 Injection Aluminium
 Führungshalterung 80x40 Aluminiumverpressung



Ref.: 106400
 Soporte Esquina Aluminio
 Aluminium corner support
 Support Angle Aluminium
 Eckenhalter Aluminium



Ref.: 106500
 Soporte Perfil 80x40 Aluminio
 Aluminium Profile Support 80x40
 Support Profil 80x40 Aluminium
 Halterung Profil 80x40 Aluminium



Ref.: 106900
 Soporte Guía Recto 80x40
 Straight guide support 80 x 40
 Support Rail de guidage Droit 80x40
 Gerade Führungshalterung 80x40



Ref.: 106199
 Soporte Guía 80x40 Extrusión Aluminio
 Extruded aluminium guide support 80 x 40
 Support Rail de guidage 80x40 Extrusion Aluminium
 Führungshalterung 80x40 Aluminiumextrusion



Ref.: 106600
 Soporte L 80x40 Aluminio
 Aluminium L support 80 x 40
 Support L 80x40 Aluminium
 Halterung "L" 80x40 Aluminium

COMPRARTOLDOS.COM

Ref.: 106300 __



Pie 80x40 Aluminio
Aluminium ground support 80 x 40
Pied 80x40 Aluminium
Sockel 80x40 Aluminium

Ref.: 109300 __



Soporte Pie 2 Agujeros 80x40
Support ground support 2 holes 80 x 40
Support Pied 2 Troues 80x40
Sockelhalter 2 Öffnungen 80x40

Ref.: 109400 __

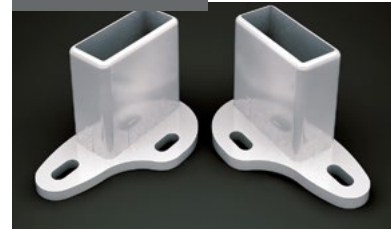

Juego de Soportes Pie Esquinero 80x40
Corner ground support kit 80 x 40
Jeu de Supports Pied Angle 80x40
Halterset Ecksockel 80x40

Ref.: 10620000

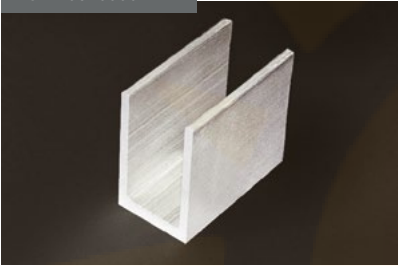

Soporte U 80x40 Aluminio
Aluminium U support 80 x 40
Support U 80x40 Aluminium
Halter U 80x40 Aluminium

Ref.: 106700 __



Soporte T 80x40 Aluminio
Aluminium T support 80x40
Support T 80x40 Aluminium
Halter T 80x40 Aluminium

Ref.: 112100 __

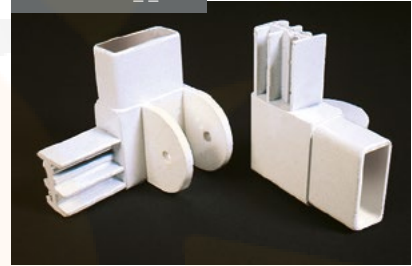

Juego Angular Articulado 80x40 Aluminio
Aluminium articulated corner support kit 80 x 40
Jeu Angulaire Articulé 80x40 Aluminium
Gelenkwinkel-Set 80x40 Aluminium

Ref.: 110500 __



Brida 80x40 Aluminio
Aluminium 80 x 40 flange
Bride 80x40 Aluminium
Aluminiumflansch 80x40

Ref.: 110600 __



Brida Esquina 80x40 Aluminio
Aluminium 80 x 40 corner flange
Bride Angle 80x40 Aluminium
Aluminium-Eckflansch 80x40

Ref.: 9304000



Regleta Soporte Guía Zamak 80x40
Zamak guide support screw plate 80 x 40
Réglette Support Rail de guidage Zamak 80x40
Leiste Führungshalterung Zamak 80x40

Ref.: 107600 __



Kit soporte pared articulado 80x40 Aluminio
Aluminium articulated wall support kit 80 x 40
Kit support mural articulé 80x40 Aluminium
Ausklappbare Wandhalterung aus Aluminium 80x40

Ref.: 110000 __

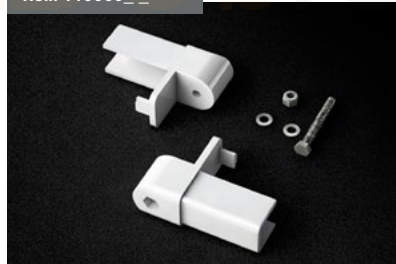

Kit doble articulado 80x40 Aluminio
Double articulated 80x40 kit in aluminum
Double articulé 80 x 40 kit en aluminium
Doppel-gelenkwinkel-kit 80x40

Ref.: 112200 __



Rótula de Estructura 80x40 Aluminio
Aluminium structure coupling 80 x 40
Rotule de Structure 80x40 Aluminium
Aluminium-Struktur Gelenk 80x40



Siplano Eléctrico 80x40



Mecanización oculta y silenciosa

Hidden and silent mechanisation

Mécanisme invisible et silencieux

Verdeckte und lautlose Mechanik

Características y aplicaciones



Sistema diseñado para motorizar toldos planos con el sistema de perfiles de medida 80x40.

Medidas máximas por módulo: 5 metros de línea por 5 metros de salida con 2 guías.

Ampliable a 9 metros de salida realizando empalmes y creando una soportación para la guía

Guía y palillera de aluminio extrusionado (UNE-L337) la cual se mecaniza con correa dentada y coronas de transmisión y retorno compuestas de poliamida y fibra de vidrio.

Sistema de enganche de la correa a la polea de arrastre de fácil ensamblaje. (Patente Siplan).

Mecanización totalmente oculta al ir por el interior de la guía.

Sistema silencioso al no existir roces mecánicos.

Characteristics and applications



System designed to motorize flat awnings with a system profile of 80 x 40.

Maximum measurements per module: 5 meters line by 5 meters projection with 2 guides.

Expandable to 9 meters using connections and creating a support for the guide.

Extruded aluminium guide and grid profile (UNE-L337) on which the dented transmission strap is mounted with the transmission and return crowns made of polyamide and fibreglass.

Easy coupling assembly of strap to drive pulley. (Siplan Patent).

The mechanization is totally hidden because it is inside the guide.

It's a very silent system because there is no mechanical friction.

Caractéristiques et les usages



Système conçu pour motoriser des pergolas avec le système de profilés de 80X40.

Mesures maximales par module: 5 mètres de largeur sur 5 mètres d'avancée avec 2 rails de guidage.

Extensible à 9 mètres d'avancée en réalisant des raccords et en créant un support pour le rail de guidage.

Rails de guidage et croisillons en aluminium extrudé (UNE-L337); l'ensemble est mécanisé grâce à la courroie dentée et les couronnes de transmission et de retour fabriquées en polyamide et en fibre de verre.

Système de fixation de la courroie à la poulie motrice facile à assembler. (Brevet Siplan).

Mécanisme invisible puisqu'il passe par l'intérieur du rail de guidage.

Système silencieux grâce à l'absence de frottements mécaniques.

Ensemble Moteur 80 (équerres et douilles incluses)

Eigenschaften und Anwendungen



System für die Motorisierung von Systemprofilen 80x40 für Flachmarkisen.

Höchstmaße pro Modul: Linie 5 x 5 Meter Ausladung mit 2 Führungen.

Mithilfe von Gelenkführungen und eine Stützpunktes für die Führungen auf 9 m Ausladung erweiterbar.

Führung und Kleinprofil aus extrudiertem Aluminium (UNEL337), an denen Zahnriemen, Radkränze und Rücklauf aus Polyamid und Glasfaser montiert werden.

Der Zahnriemen kann leicht an die Zuglaufrolle angehängt werden. (Patent Siplan).

Mechanik und Motorisierung sind vollständig im Innern des Antriebsrohrs verdeckt.

Lautloses System ohne mechanische Reibungen.

Motor 40Nm 40Nm motor Moteur 40 Nm Motor 40 Nm

Ref.: 1400 ____



Perfil de Transmisión Ø76
Transmission profile Ø76
Profilé de Transmission Ø76
Antriebsprofil Ø76

Ref.: 1310 ____



Guía 80x40x2
Guide 80 x 40 x 2
Rail de guidage 80x40x2
Führung 80x40x2

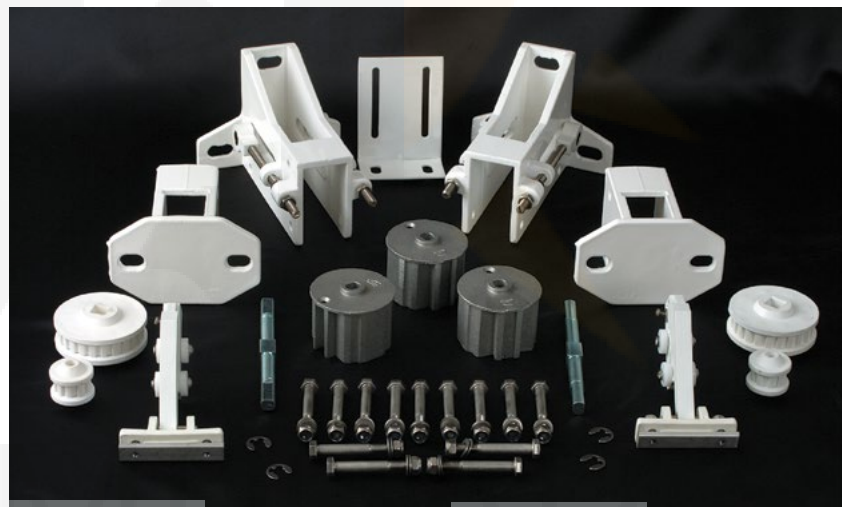

Ref.: 114000 __

Conjunto Motor 80 (incluye escuadras y casquillos)
Kit motor 80 (plug and valve holders included)
Ensemble Moteur 80 (équerres et douilles incluses)
Motoreinheit 80 (inkl. Winkel und Buchsen)

Ref.: 115000 __

Conjunto Motor 95x40 (incluye escuadras y casquillos)
Kit 95x40 motor (plug and valve holders included)
Ensemble Moteur 95x40 (équerres et douilles incluses)
Motoreinheit 95x40 (inkl. Winkel und Buchsen)

Ref.: 11540000



Correa Dentada
Dented belt

Courroie Dentée
Pfette

LINEA TOLDO / AWNING LINE AUVENT EN LARGEUR / LINIE DER MARKISE		
SALIDA (m) PROJECTION AVANCÉE AUSLADUNG	5	10
LÍNEA HASTA 7 m. LINE UP TO 7 m. LARGEUR JUSQU'À 7 m. LINIE BIS 7 m.	30/17	40/17
LÍNEA HASTA 12 m. LINE UP TO 12 m. LARGEUR JUSQU'À 12 m. LINIE BIS 12 m.	70/17	85/17

Siplano Eléctrico 80x40

Despiece - Siplano parts: exploded view - Siplano électrique Vue éclatée - Komponenten der Siplano

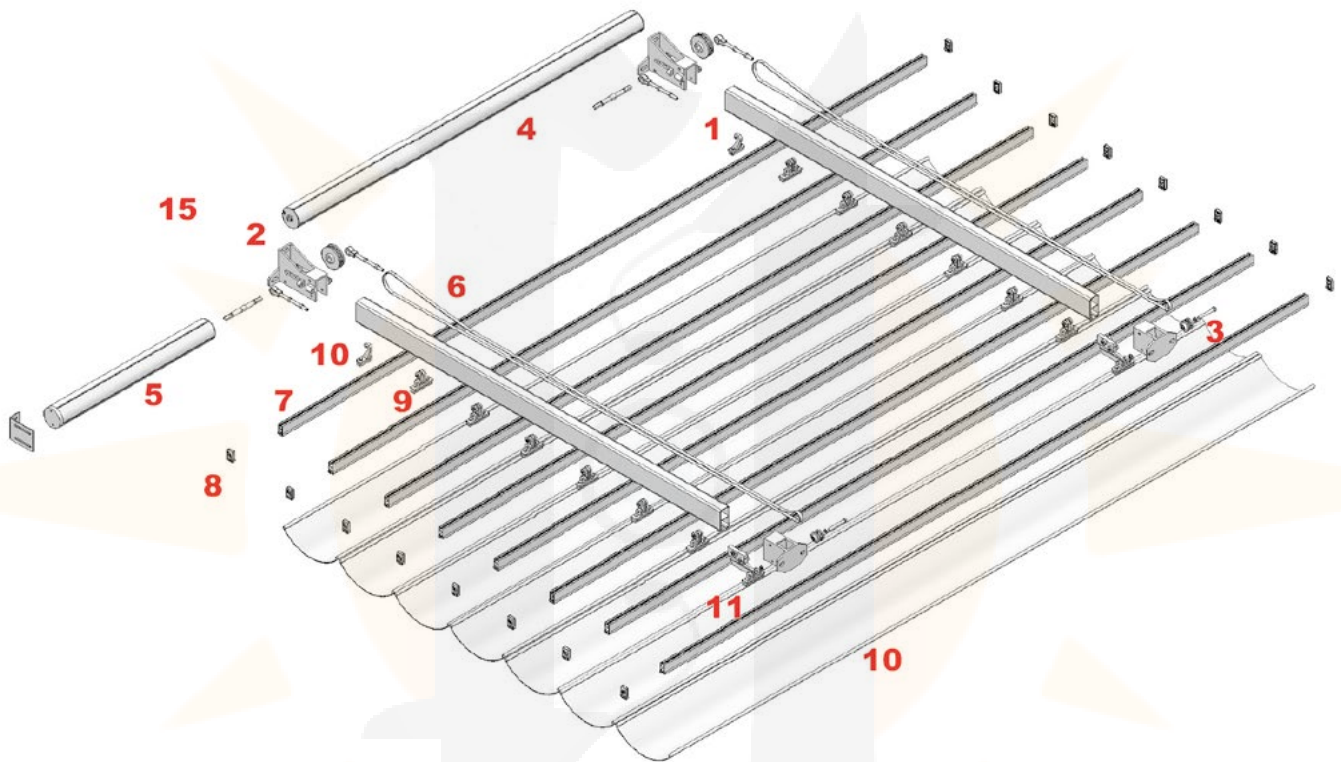

- 1: Guía
- 2: Soporte motriz
- 3: Soporte retorno
- 4: Tubo de transmisión
- 5: Motor
- 6: Correa de transmisión
- 7: Perfil palillera
- 8: Tapón perfil palillera
- 9: Polea móvil
- 10: Polea final
- 11: Polea de arrastre



- 1: Guide
- 2: Drive support
- 3: Return support
- 4: Transmission tube
- 5: Motor
- 6: Belt drive
- 7: Profile sliding bar
- 8: Plug profile sliding bar
- 9: Mobile pulley
- 10: Final pulley
- 11: Drive pulley



- 1: Glissière
- 2: Support poulie motrice
- 3: Support poulie de renvoi
- 4: Tube de transmission
- 5: Moteur
- 6: Courroie de transmission
- 7: Profilé tringlerie
- 8: Bouchon profilé tringlerie
- 9: Poulie mobile
- 10: Poulie finale
- 11: Poulie d'entraînement



- 1: Führung
- 2: Halterung Antrieb
- 3: Halterung Rücklauf
- 4: Gelenkwellenrohr
- 5: Getriebe
- 6: Treibriemen
- 7: Profil Einsetzelemente
- 8: Stopfen Profil Einsetzelemente
- 9: Mobile Riemenscheibe
- 10: Ende Riemenscheibe
- 11: Transport-Riemenscheibe



PERGO-SUN 96

system 

Características y aplicaciones



Completando el sistema tenemos la variante 90x96 mm., aún más robusta, de perifería cuadrada.

Esta variante del diseño del sistema aporta un toque extra de solidez visual, manteniendo todas las opciones que nos brinda la esfera.

Con el sistema se reduce considerablemente el número de piezas en stock necesarias para acometer cualquier proyecto de toldo plano.

La gran versatilidad del sistema supera las limitaciones que plantean otros sistemas.

Medidas máximas por módulo: 6 metros de línea por 6 metros de salida con 2 guías

100% ROBUSTEZ

Characteristics and applications



Completing the system we have the option 90 x 96 mm., even more robust and with square profiling.

This design variant of the system adds extra visual solidity, keeping all the elements that the sphere gives us.

With the system there is a considerable reduction in the number of parts needed to undertake any flat awning project.

The great versatility of the system overcomes the limitations posed by other systems.

Maximum measurements per module: 6 meters line by 6 meters projection with 2 guides.

100% STRENGTH

Caractéristiques et les usages



Pour compléter le système, nous proposons l'option 90x96 mm, encore plus robuste, aux profilés carrés.

Cette option du design du système apporte un plus de force visuelle, tout en conservant les options apportées par la sphère.

Grâce au système, on réduit considérablement le nombre de pièces en stock nécessaire à tout projet de pergola.

La grande polyvalence du système va au-delà des limites que présentent d'autres systèmes.

Mesures maximales par module: 6 mètres de largeur sur 6 mètres d'avancée avec 2 rails de guidage.

100% ROBUSTESSE

Eigenschaften und Anwendungen



Zur Vervollständigung des Systems haben wir die noch robustere, quadratische 90x96mm Variante gebaut.

Diese Variante des Designs des Systems bringt einen zusätzlichen Hauch von Gediegenheit und hat alle Optionen, die uns das Kreisprofil bietet.

Mit dem wird auch das Lagersortiment an Komponenten wesentlich reduziert.

Die Vielseitigkeit des Systems überschreitet die Grenzen, die anderen Systemen gesetzt sind.

Höchstabmessungen pro Modul: Linie 6 x 6 Meter Ausladung mit 2 Führungen.

100% ROBUSTHEIT

Ref.: 1742_ _ _ _



Juego Angular Articulado 90x96
Angular articulated set 90 x96
Jeu d'angle articulé 90x96
Gelenkwinkel-set 90x96

Ref.: 171400_ _



Pie 90x96
Ground support 90 x 96
Pied 90x96
Sockel 90x96

Ref.: 172300_ _



Soporte Guía 90x96
Guide Support 90 x 96
Support Rail de guidage 90x96
Führungshalterung 90x96

Ref.: 1741_ _ _ _



Soporte L 90x96
L supports 90 x 96
L supports 90 X 96
L-Halterung 90x96

Ref.: 1445_ _ _ _



Guía 90x96
Guide 90 x 96
Rail de guidage 90x96
Führung 90x96

Ref.: 1420_ _ _ _



Perfil 90x96
Profile 90 x 96
Profilé 90x96
Profil 90x96

Ref.: 171700_ _



Tapón Adaptador 90x96
Adapter cap 90 x 96
Cache Adaptateur 90x96
Stopfen Adapter 90x96

Ref.: 17400050



Empalme Guía y perfil 90x96
Guide connection and profile 90 x 96
Raccord Rail de guidage et profilé 90x96
Führungsanschluss und Profil 90x96

Ref.: 1450_ _ _ _



Perfil 90x96 2 ranuras
90 x 96 profile 2 slots
90 x 96 profil 2 équerres
Stange 90x96 2 schlitzen

Ref.: 174300 __



SopORTE T 90x96
T supports 90 x 96
T supports 90 X 96
T-Halterung 90x96

Ref.: 118300 __



SopORTE Guía 96x70
Guide Support 96x70
Support Rail de guidage 96x70
Führungshalterung 96x70

Ref.: 1451 ____



Guía 96x70
Guide 96x70
Rail de guidage 96x70
Führung 96x70



También se han diseñado nuevos terminales y capiteles para poder montar pérgolas decorativas con esta nueva perfilera.



There are also newly designed terminals and spires to be used in the assembly of decorative pergolas.



On a également conçu de nouvelles griffes et des chapiteaux pour pouvoir monter des pérgolas de décoration avec ces nouveaux profilés.



Außerdem wurden neue Terminals und Kapitelle für die Montage von dekorativen Pergolen mit diesen neuen Profilen entworfen.

Ref.: 172600 __



SopORTE Capitel Pecho Paloma 90x96
Double corbel terminal support 90 x 96
Support Chapiteau Finition arrondie 90x96
Halterung Kapitell Zierleiste 90x96

Ref.: 172500 _



Terminal Pecho Paloma 90x96
Corbel Terminal 90 x 96
Griffe Finition arrondie 90x96
Terminal Zierleiste 90x96

Ref.: 172400 __



SopORTE Pérgola 90x96
Pergola support 90 x 96
Support Pergola 90x96
Halterung Pergola 90x96

pérgolas

COMPRAR
TOLDOS

El motorizado más robusto y versátil

The most robust and versatile powered version

Le store motorisé le plus robuste et polyvalent

Die robusteste und vielseitigste Motorisierung



PERGO-SUN 96 
eléctrico



Características y aplicaciones



Sistema diseñado para motorizar toldos planos con el sistema de perfiles de medida 96x70.

Medidas máximas por módulo: 6 metros de línea por 6 metros de salida con 2 guías. Posibilidad de 3 o más guías motorizadas.

Ampliable a 9 metros de salida realizando empalmes y creando una soportación para la guía.

Guía y palillera de aluminio extrusionado (UNE-L337) en la cual se monta la correa de transmisión dentada con las coronas de transmisión y retorno compuestas de poliamida y fibra de vidrio.

Sistema de enganche de la correa a la polea de arrastre de fácil ensamblaje.

Mecanización totalmente oculta al ir por el interior de la guía.

Sistema silencioso al no existir roces mecánicos.

Characteristics and applications



System designed to motorize flat awnings with a system profile of 96x70.

Maximum measurements per module: 6 meters line by 6 meters projection with 2 guides. Possibility of 3 or more motorized guides.

Expandable to 9 meters using connections and creating a support for the guide.

Extruded aluminium guide and grid profile (UNEL337) on which the dented transmission strap is mounted with the transmission and return crowns made of polyamide and fibreglass.

Easy coupling assembly of strap to drive pulley.

The mechanization is totally hidden because they are inside the guide.

It's a very silent system because there is no mechanical friction.

Caractéristiques et les usages



Système conçu pour motoriser des pergolas avec le système de profilés de 96x70.

Mesures maximales par module : 6 mètres de largeur sur 6 mètres d'avancée avec 2 rails de guidage. C'est possible d'avoir 3 ou plus guides motorisés.

Extensible à 9 mètres d'avancée en réalisant des raccords et en créant un support pour le rail de guidage.

Rails de guidage et croisillons en aluminium extrudé (UNEL337) sur lesquels est montée la courroie de transmission dentée avec les couronnes de transmission et de retour fabriquées en polyamide et en fibre de verre.

Système de fixation de la courroie à la poulie motrice facile à assembler.

Mécanisme invisibles puisqu'ils passent par l'intérieur du rail de guidage.

Système silencieux grâce à l'absence de frottements mécaniques.

Eigenschaften und Anwendungen



System für die Motorisierung von Systemprofilen 96x70. für Flachmarkisen.

Höchstmaße pro Modul: Linie 6 x 6 Meter Ausladung mit 2 Führungen. Möglichkeit von drei oder mehr motor-profile.

Mithilfe von Gelenkführungen und eine Stützpunktes für die Führungen auf 9 m Ausfahren erweiterbar.

Führung und Kleinprofil aus extrudiertem Aluminium (UNEL337), an denen Zahnriemen, Radkränze und Rücklauf aus Polyamid und Glasfaser montiert werden.

Der Zahnriemen kann leicht an die Zuglaufrolle angehängt werden.

Mechanik sind vollständig im Innern des Führung.

Lautloses System ohne mechanische Reibungen.

LINEA TOLDO AWNING LINE - AUVENT EN LARGEUR - LINIE DER MARKISE			
Ø70	SALIDA (m) PROJECTION AVANCÉE AUSLADUNG	6	9
	LÍNEA HASTA 7 m. LINE UP TO 7 m. LARGEUR JUSQU'À 7 m. LINIE BIS 7 m.	30/17	40/17
	LÍNEA HASTA 12 m. LINE UP TO 12 m. LARGEUR JUSQU'À 12 m. LINIE BIS 12 m.	70/17	85/17

Ref.:118500__

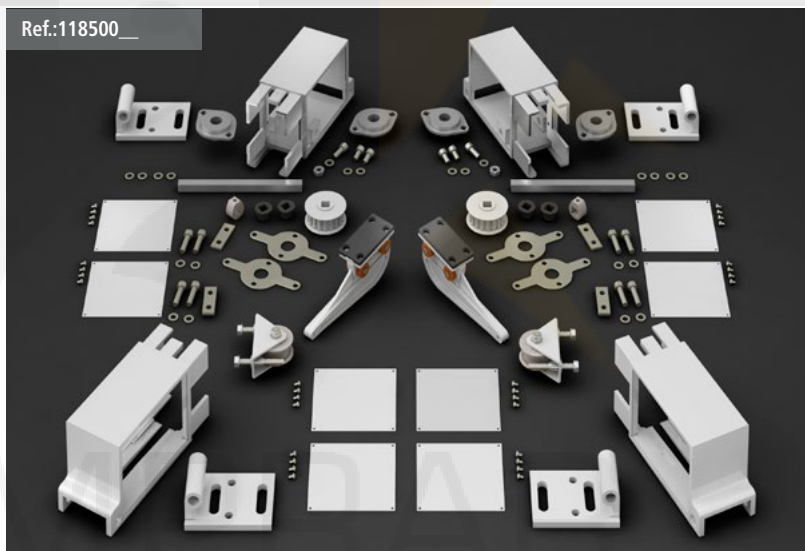

Conjunto Motor 90x96 (incluye escuadras y casquillos)
Kit motor 90x96 (plug and valve holders included)
Ensemble Moteur 90x96 (équerres et embouts inclus)
Motoreinheit 90x96 (inkl. Winkel und Buchsen)

Ref.:1451__



Guía 96x70
Guide 96x70
Rail de guidage 96x70
Führung 96x70

Ref.: 1463__



Tubo Transmisión Ø80 mm.
Transmission tube Ø80 mm.
Tube de transmission Ø80 mm.
Übertragungsrohr Ø80 mm

Ref.: 148100__



Correa Dentada
Dented strap
Courroie Dentée
Zahnriemen

Pergo-Sun Eléctrico 96

Despiece - Siplano parts: exploded view - Siplano électrique Vue éclatée - Komponenten der Siplano

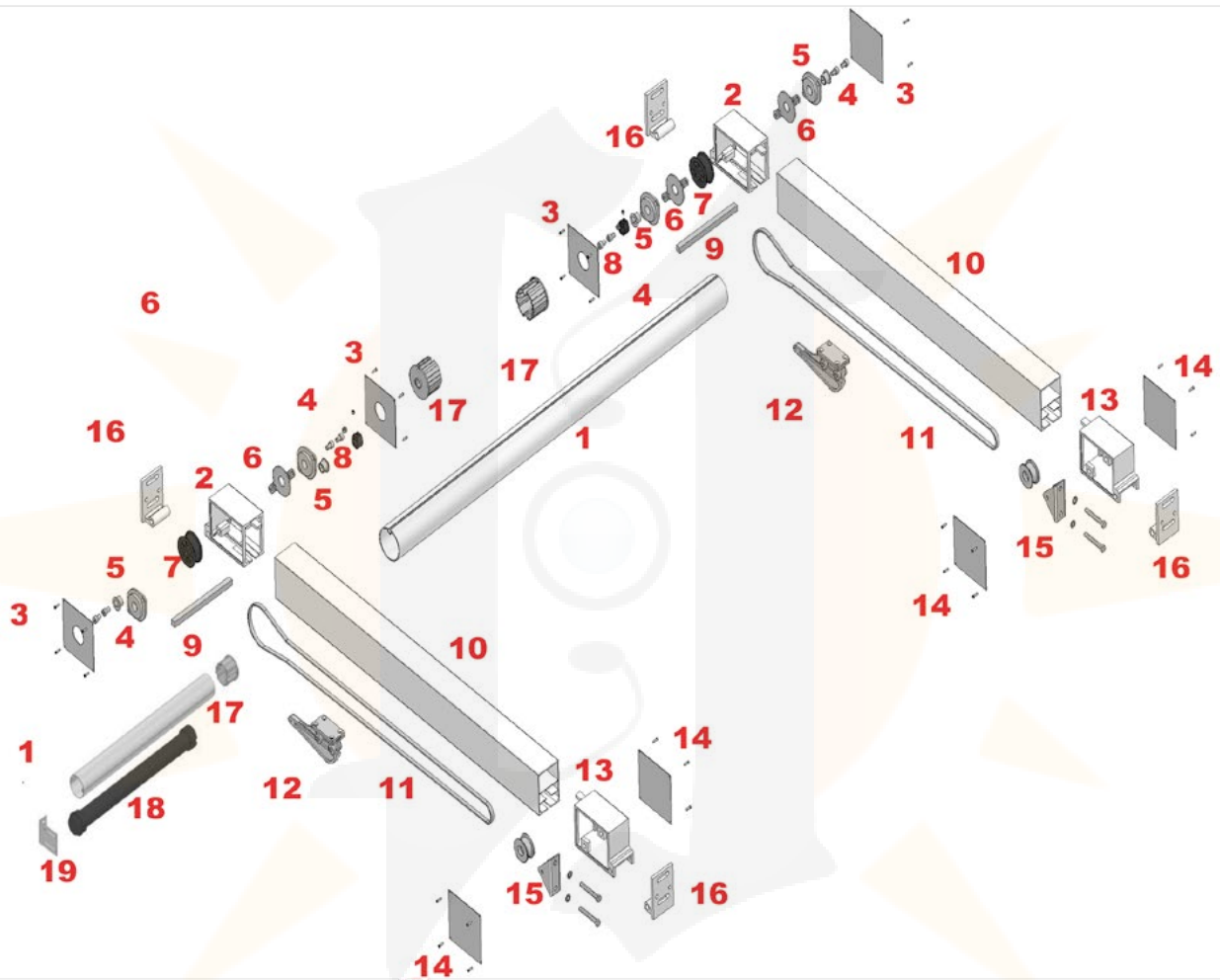

- 1: Tubo de transmisión 80mm
- 2: Soporte motriz
- 3: Tapa soporte motriz
- 4: Adaptador eje de 13mm
- 5: Rodamiento
- 6: Acople intermedio
- 7: Polea motriz
- 8: Freno eje de 13mm
- 9: Eje cuadrado de 13mm
- 10: Guía 96x70
- 11: Correa
- 12: Polea de arrastre
- 13: Soporte retorno
- 14: Tapa soporte retorno
- 15: Tensor
- 16: Placa pared
- 17: Casquillo punta sin eje 80mm
- 18: Motor
- 19: Soporte motor



- 1: Transmission tube 80 mm.
- 2: Drive support
- 3: Cover drive support
- 4: Shaft adaptor 13 mm.
- 5: Bearing
- 6: Intermediate coupling
- 7: Drive pulley
- 8: Brake 13 mm shaft
- 9: 13mm square shaft
- 10: Guide 96x70
- 11: Belt
- 12: Drive pulley
- 13: Return support
- 14: Return support cover
- 15: Tensor
- 16: Wall plate
- 17: Plug without stud 80mm
- 18: Motor
- 19: Motor support



- 1: Tube de transmission 80 mm.
- 2: Support moteur
- 3: Joue support moteur
- 4: Axe Adaptateur 13 mm.
- 5: Roulement
- 6: Raccord intermédiaire
- 7: Poulie motrice
- 8: Frein d'axe 13mm
- 9: Axe carré 13mm
- 10: Rail de guidage 96x70
- 11: Courroie
- 12: Poulie d'entraînement
- 13: Support retour
- 14: Joue Support retour
- 15: Tendeur
- 16: Platine murale
- 17: Embout Côté opposé au treuil sans Axe 80mm
- 18: Moteur
- 19: Support moteur



- 1: Antriebsrohr 80 mm.
- 2: Antriebshalterung
- 3: Abdeckung der Antriebshalterung
- 4: Achse Adapter 13 mm.
- 5: Metallwälzlager
- 6: Zwischenquerstrebgarnitur
- 7: Motorriemenscheibe
- 8: Achsenbremse 13mm
- 9: Platz Achse 13mm
- 10: Führung 96x70
- 11: Zahnriemen
- 12: Zuglaufrolle
- 13: Rücklaufhalterung
- 14: Abdeckung der Rücklaufhalterung
- 15: Tensor
- 16: Wandplatte
- 17: Buchsenstift ohne Achse 80mm
- 18: Motor
- 19: Antriebshalterung



PERGO-SUN 125 system

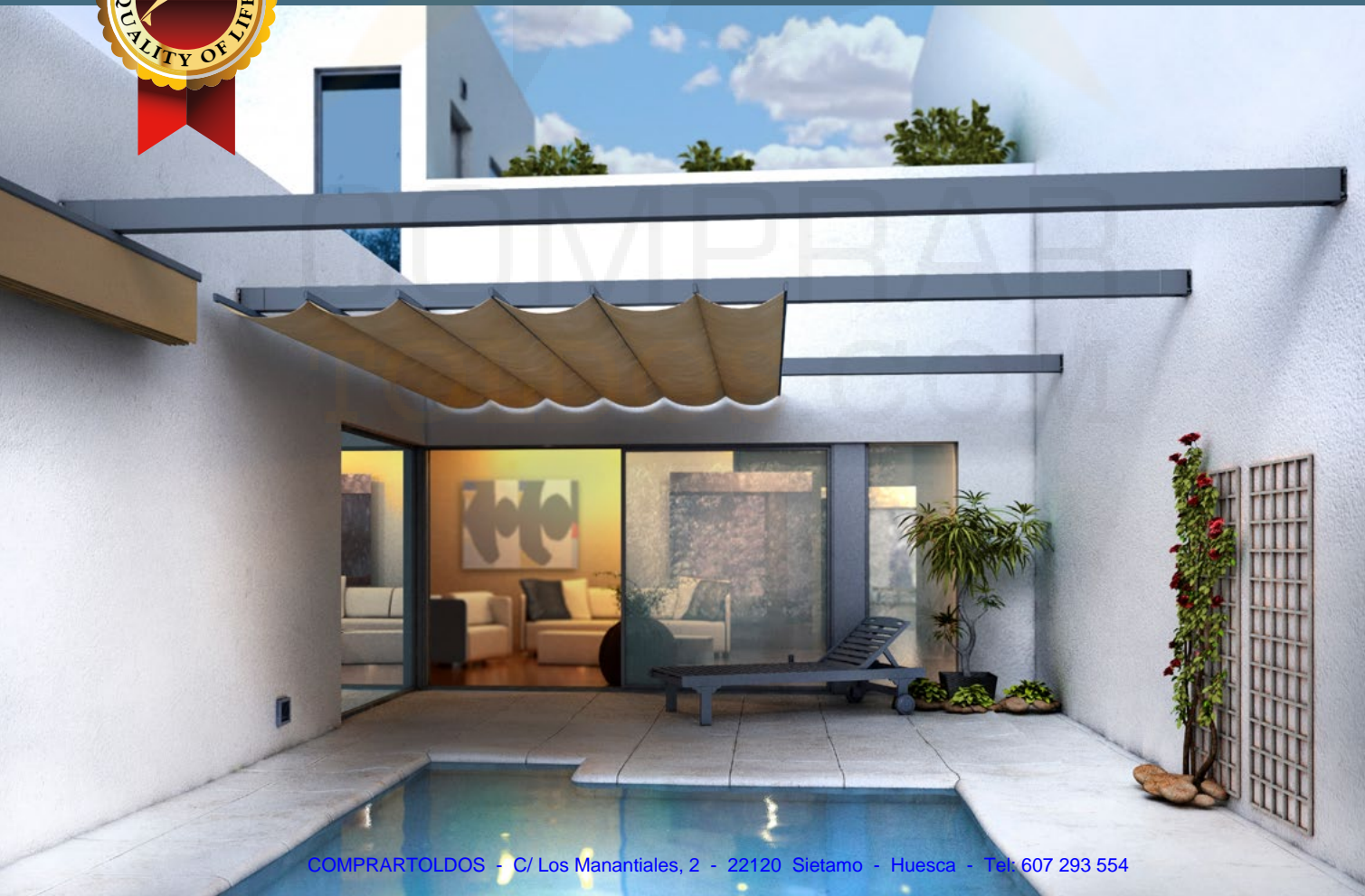

Características y aplicaciones



Sistema con aplicación en el montaje de toldos de dimensiones grandes, para ser montado con perfil de 125x125 y guías de 125x80.

La línea máxima es 7 m.

Salida máxima recomendada: 7 m.

Characteristics and applications



System for assembly of large dimension awnings, to be mounted with profiles of 125 x 125 and guides of 125 x 80.

Maximum length: 7 m.

Maximum projection recommended: 7 m.

Caractéristiques et les usages



Système qui peut être utilisé dans le montage de stores de grandes dimensions, monté sur un profilé de 125x125 et des rails de guidage de 125x80.

La largeur maximale est de 7 m.

Avancée maximale recommandée : 7 m.

Eigenschaften und Anwendungen



Montagesystem für Markisentuch mit großen Abmessungen, die mit einem Profil von 125x125 und Führungen von 125x80 montiert werden.

Maximale Linie: 7m.

Empfohlenes maximales Ausfahren: 7 m.



Pergo-Sun 125



Ref.: 1462
Perfil 125x80
Profile 125x80
Profilé 125x80
Profil 125x80



Ref.: 1463
Guía 125x80
Guide 125x80
Rail de guidage 125x80
Führung 125x80



Ref.: 1460
Perfil Regletero 125
Strip Profile 125
Profiel de Réglette 125
Verlängerungsprofil 125



Ref.: 1466
Perfil 125x125
Profile 125x125
Profilé 125x125
Profil 125x125

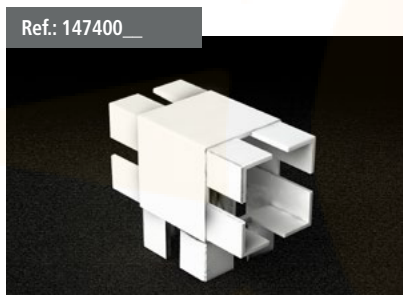

Ref.: 147400
Soporte T 125
T 125 Support
Support T 125
T 125 Halter



Ref.: 147300
Soporte L 125
L 125 Support
Support L 125
L 125 Halter

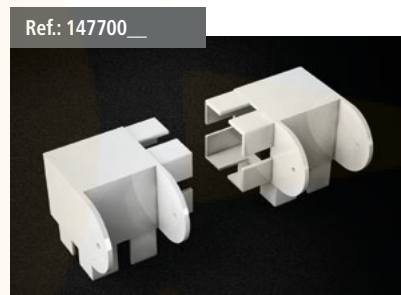

Ref.: 147700
Juego Angular articulado 125x125
Angular jointed kit 125 x 125
Jeu Angulaire Articulé 125x125
Kit Gelenkwinkel 125x125



Ref.: 147100
Pie 125
Ground support 125
Pied 125
Sockel 125



Ref.: 147200
Pie esquinero 125x125
Corner ground support 125 x 125
Pied coin 125x125
Ecksockel 125x125



Ref.: 147600
Soporte perfil pérgola / guía 125x80
Pergola / guide Support 125x80
Support pergola / Rail de guidage 125x80
Halterung Pergola / Führung 125x80



Ref.: 147500
Pecho paloma 125x80
Corbel 125 x 80
Finition arrondie 125x80
Zierleiste 125x80



Ref.: 147000
Tapón adaptador 125
Adapter cap 125
Cache adaptateur 125
Stopfen Adapter 125



Ref.: 147800
Tapón 125x80
Cap 125x80
Cache 125x80
Stopfen 125x80



Ref.: 1479050
Empalme Guía 125x80
Guide connection 125x80
Raccord Rail de guidage 125x80
Führungsanschluss 125x80



PERGO-SUN 125
eléctrico 

Características y aplicaciones



Sistema diseñado para motorizar toldos planos con el sistema de perfiles de medida 125x80. Producto de confección y montaje fácil y rápido permitiendo un alto acabado estético y funcional del conjunto.

Medidas máximas por módulo: 7 metros de línea por 7 metros de salida con 2 guías.

Posibilidad de 3 o más guías motorizadas.

Ampliable a 9 metros de salida realizando empalmes y creando una soportación para la guía

Guía y palillería de aluminio extrusionado (UNE-L337) la cual se mecaniza con correa dentada y coronas de transmisión y retorno compuestas de poliamida y fibra de vidrio.

Sistema de enganche de la correa a la polea de arrastre de fácil ensamblaje.

Mecanización totalmente oculta al ir por el interior de la guía.

Sistema silencioso al no existir roces mecánicos.

Characteristics and applications



System designed to motorize flat awnings with system profiles of 125 x 80. Product that is quick and easy to prepare and assemble, that looks good and is very functional.

Maximum measurements per module: 7 meters line by 7 meters projection with 2 guides.

Expandable to 9 meters using connections and creating a support for the guide.

Guide and grid profile made of extruded aluminium (UNE L-337) mechanized with dented strap and transmission and return crowns made of polyamide and fibreglass.

Easy coupling assembly of strap to drive pulley.

The mechanization is totally hidden because is covered by the guide.

It's a very silent system because there is no mechanical friction.

Caractéristiques et les usages



Système conçu pour motoriser les pergolas grâce au système de profilés 125x80. Produit dont la confection et le montage sont faciles et rapides et qui apporte une excellente finition esthétique et fonctionnelle à l'ensemble.

Mesures maximales par module : 7 mètres de largeur sur 7 mètres d'avancée avec 2 rails de guidage.

Extensible à 9 mètres d'avancée à l'aide de raccords et de supports pour le rail de guidage.

Rail de guidage et croisillons en aluminium extrudé (UNE-L337) mécanisés par une courroie dentée et des couronnes de transmission et de retour fabriquées en polyamide et en fibre de verre.

Système de fixation de la courroie à la poulie d'entraînement facile à assembler.

Mécanisation totalement invisible à l'intérieur du rail de guidage.

Système silencieux en raison de l'absence de frottements mécaniques.

Eigenschaften und Anwendungen



System für die Motorisierung von Flachmarkisen mit Systemprofilen von 125x80. Leicht anpassbares und montierbares Produkt mit hohem ästhetischem Anspruch und Funktionalität.

Höchstmaße pro Modul: Linie 7 x 7 Meter Ausladung mit 2 Führungen.

Erweiterbar auf bis zu 9 Metern mittels Einsatz von Gelenken und Unterstützung der Führung.

Führung und Kleinprofil aus extrudiertem Aluminium (UNE-L337), das mit Zahnriemen, Radkränzen und Rücklauf aus Polyamid und Glasfaser ausgestattet ist.

Der Zahnriemen kann leicht an die Zuglaufrulle eingehängt werden.

Die Mechanik im Innern der Führung ist vollständig abgedeckt.

Lautloses und reibungsloses System.

LINEA TOLDO AWNING LINE - LARGEUR STORE - LINIE DER MARKISE		
SALIDA (m) PROJECTION AVANCÉE AUSLADUNG	7	9
LÍNEA HASTA 7 m. LINE UP TO 7 m. LARGEUR JUSQU'À 7 m. LINIE BIS 7 m.	30/17	40/17
LÍNEA HASTA 12 m. LINE UP TO 12 m. LARGEUR JUSQU'À 12 m. LINIE BIS 12 m.	70/17	85/17

Ref.: 148000__



Conjunto Motor 125x80 (incluye escuadras y casquillos) / Kit motor 125 x 80 (plug and valve holders included)
Ensemble Moteur 125x80 (équerres et embouts inclus) / Motoreinheit 125x80 (inkl. Winkel und Buchsen)

Ref.: 1463__



Guía 125x80
Guide 125x80
Rail de guidage 125x80
Führung 125x80

Ref.: 1463__



Tubo Transmisión Ø80 mm.
Transmission tube Ø80 mm.
Tube de transmission Ø80 mm.
Übertragungsrohr Ø80 mm

Ref.: 148100__



Correa Dentada
Dented strap

Courroie Dentée
Zahnriemen

Pergo-Sun Eléctrico 125

Despiece - Electric PergoSun: exploded view

Vue éclatée des pièces - Elektronische Komponenten PergoSun

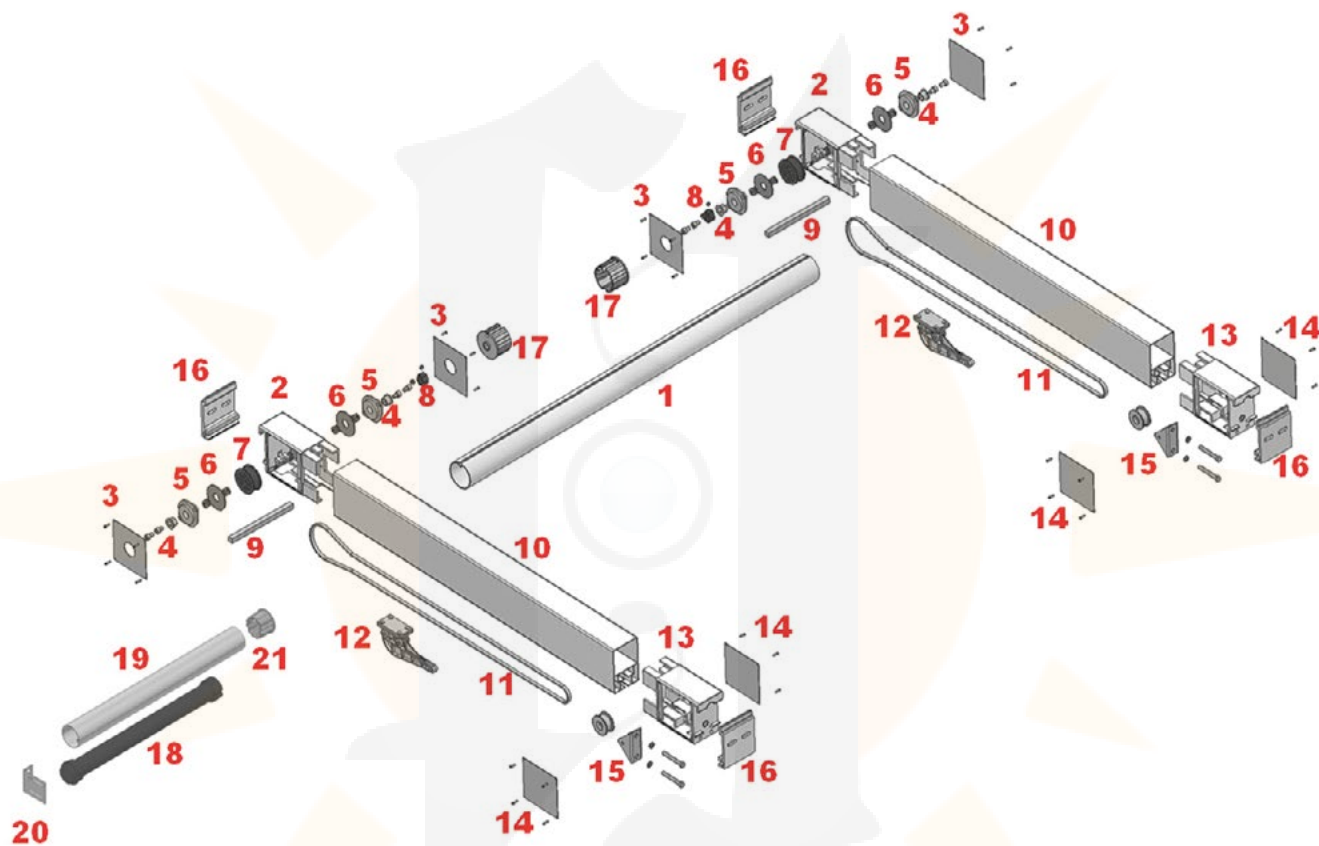

- 1: Tubo de transmisión 80mm
- 2: Soporte motriz
- 3: Tapa soporte motriz
- 4: Adaptador eje de 13mm
- 5: Rodamiento
- 6: Acople intermedio
- 7: Polea motriz
- 8: Freno eje de 13mm
- 9: Eje cuadrado de 13mm
- 10: Guía 125x80
- 11: Correa
- 12: Polea de arrastre
- 13: Soporte retorno
- 14: Tapa soporte retorno
- 15: Tensor
- 16: Placa pared
- 17: Casquillo tubo de transmisión
- 18: Motor
- 19: Tubo de enrollado 78mm
- 20: Soporte motor
- 21: Casquillo enrollado 78mm



- 1: Transmission tube 80 mm.
- 2: Drive support
- 3: Cover drive support
- 4: Shaft adaptor 13 mm.
- 5: Bearing
- 6: Intermediate coupling
- 7: Drive pulley
- 8: Brake 13 mm shaft
- 9: 13mm square shaft
- 10: Guide 125 x 80
- 11: Belt
- 12: Drive pulley
- 13: Return support
- 14: Return support cover
- 15: Tensor
- 16: Wall plate
- 17: Transmission valve holder
- 18: Motor
- 19: Roller tube 78mm
- 20: Motor support
- 21: Rolling valve holder 78mm



- 1: Tube de transmission 80 mm.
- 2: Support moteur
- 3: Joue support moteur
- 4: Axe Adaptateur 13 mm.
- 5: Roulement
- 6: Raccord intermédiaire
- 7: Poulie motrice
- 8: Frein d'axe 13mm
- 9: Axe carré 13mm
- 10: Rail de guidage 125x80
- 11: Courroie
- 12: Poulie d'entraînement
- 13: Support retour
- 14: Joue Support retour
- 15: Tendeur
- 16: Platine murale
- 17: Embout tube de transmission
- 18: Moteur
- 19: Tube d'enroulement 78mm
- 20: Support moteur
- 21: Embout enroulement 78mm



- 1: Antriebsrohr 80 mm.
- 2: Antriebshalterung
- 3: Abdeckung der Antriebshalterung
- 4: Achse Adapter 13 mm.
- 5: Metallwälzlager
- 6: Zwischenquerstrebgarnitur
- 7: Motorriemenscheibe
- 8: Achsenbremse 13mm
- 9: Platz Achse 13mm
- 10: Führung 125x80
- 11: Zahnriemen
- 12: Zuglaufrolle
- 13: Rücklaufhalterung
- 14: Abdeckung der Rücklaufhalterung
- 15: Tensor
- 16: Wandplatte
- 17: Antriebsbuchsen
- 18: Motor
- 19: Tuchwalze 78mm
- 20: Antriebshalterung
- 21: Rollventilhalterung 78mm