

COMPRAR
TOLDOS.COM

PARASOLES

CATÁLOGO 2026



Parasol de aluminio lacado con 4 varillas. Apertura tipo push-up con pulsador de desbloqueo. Punteras elásticas para la fijación del tejido. Confeccionado en una sola pieza. Sin volante y sin fugavientos

Guarda-sol de alumínio lacado com 4 varetas. Abertura tipo push-up com botão de desbloqueio. Pontas elásticas para fixação do tecido. Confeccionado numa só peça. Sem bambinela e sem fugavientos.

Lacquered aluminium parasol with 4 ribs. Push-up open system with release button. Elastic tips for fabric attachment. Made in a single piece. Without valance and without airvent.

Parasol en aluminium laqué avec 4 baleines. Ouverture push-up avec bouton de déverrouillage. Embouts élastiques pour la fixer le tissu. Confectionné en une seule pièce. Sans volant ni soufflet



white

taupe

anthracite

Tamaños/Tamanhos/Sizes/Tailles

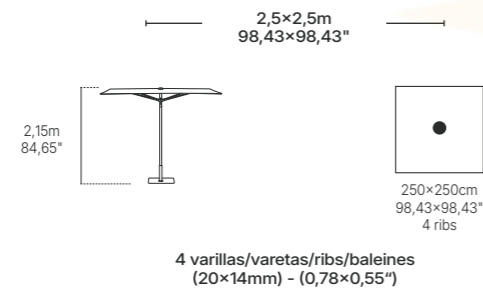

4 varillas/varetas/ribs/baleines
(20x14mm) - (0,78x0,55")

Tejidos/Tecidos/Fabrics/Tissus



Referencias/Referências/References/Références



Color frame	3x3m - 118,11x118,11"
<input type="checkbox"/> white	SIAO10C2504700P
<input type="checkbox"/> taupe	SIAO10C2504800P
<input type="checkbox"/> anthracite	SIAO10C2504600P

Bases / Pieds (Pag. 194/198)

FIX, FAST CLICK, BOND Ø60, LOOP Ø60, CANTO Ø60, KUBO MINI



COMPRAR
TOLDOS.COM



R. D. No. 007003710
Utility model No. 201931894



Tamaños/Tamanhos/Sizes/Tailles

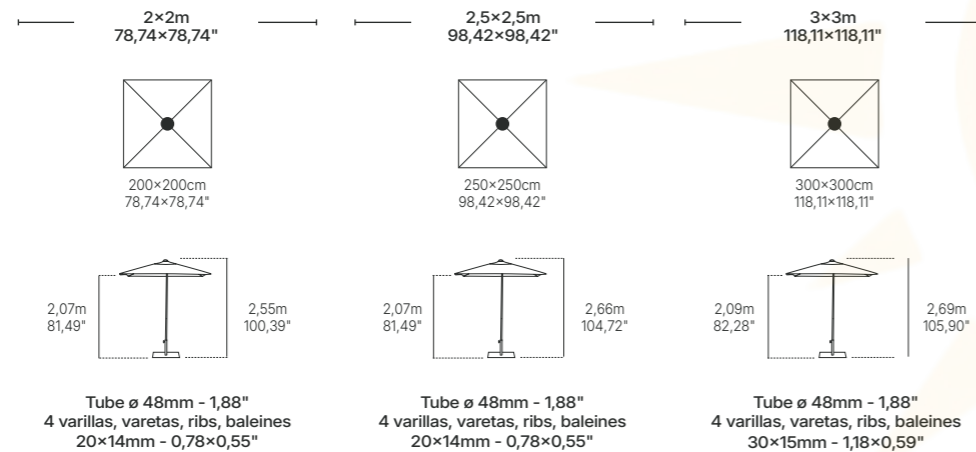

Tejidos/Tecidos/Fabrics/Tissus

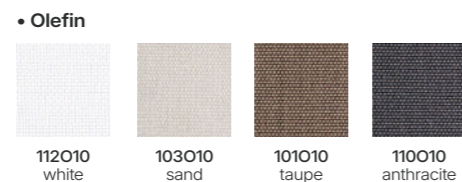

Referencias/Referências/References/Références

Color frame	2x2m - 78,74x78,74"	2,5x2,5m - 98,42x98,42"	3x3m - 118,11x118,11"
white	SPAO10C2002721P	SIAO10C2502720P	SGAO10C3002720P
taupe	SPAO10C2002821P	SIAO10C2502820P	SGAO10C3002820P
anthracite	SPAO10C2002621P	SIAO10C2502620P	SGAO10C3002620P

Bases / Pieds (Pag. 194/198)

FIX Ø60, FAST CLICK Ø60, BOND Ø60, LOOP Ø60, CANTO Ø60, KUBO MINI



el parasol que purifica el aire

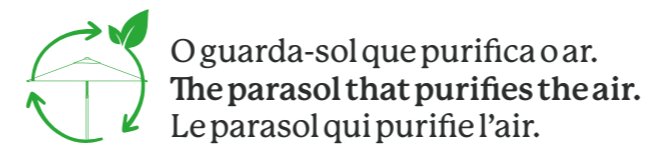

Al igual que los árboles, el tejido de este parasol descontamina el aire de las ciudades, neutraliza los gases de los motores y otras sustancias nocivas. Incorpora una nanotecnología que, en contacto con la luz solar, convierte las sustancias contaminantes del aire en sales inertes.

Tal como as árvores, o tecido deste guarda-sol descontamina o ar das cidades, neutraliza os gases dos motores e outras substâncias nocivas. Tem incorporada uma nanotecnologia que, em contacto com a luz solar, converte as substâncias contaminantes do ar em sais inertes.

Much like trees, the fabric of this umbrella reduces city pollution, neutralizing engine gases and other harmful substances. Its nanotechnology, upon contact with sunlight, turns air pollutants into inert salts.

Tout comme les arbres, le tissu de ce parasol décontamine l'air des villes et neutralise les gaz d'échappement des moteurs et d'autres substances nocives. Il intègre une nanotechnologie qui, en contact avec la lumière du soleil, transforme les substances contaminantes de l'air en sels inertes.



R. D. No. 007003710
Utility model No. 20193185



Parasol de aluminio lacado con 4 varillas. Apertura tipo push-up con sistema abre/cierra y pulsador de bloqueo. Sin volante y con fugaventos.

Guarda-sol em alumínio lacado com 4 varetas. Abertura tipo push-up com sistema abre/fecha e botão de bloqueio. Sem bambinela e com fugaventos.

Lacquered aluminum parasol with 4 ribs. Easy push-up open system with an open-lock handle. Without valance and with airvent.

Parasol aluminium laqué avec 4 baleines. Ouverture push-up avec système d'ouverture / fermeture et verrouillage. Sans volant et avec soufflet.

Tamaños/Tamanhos/Sizes/Tailles

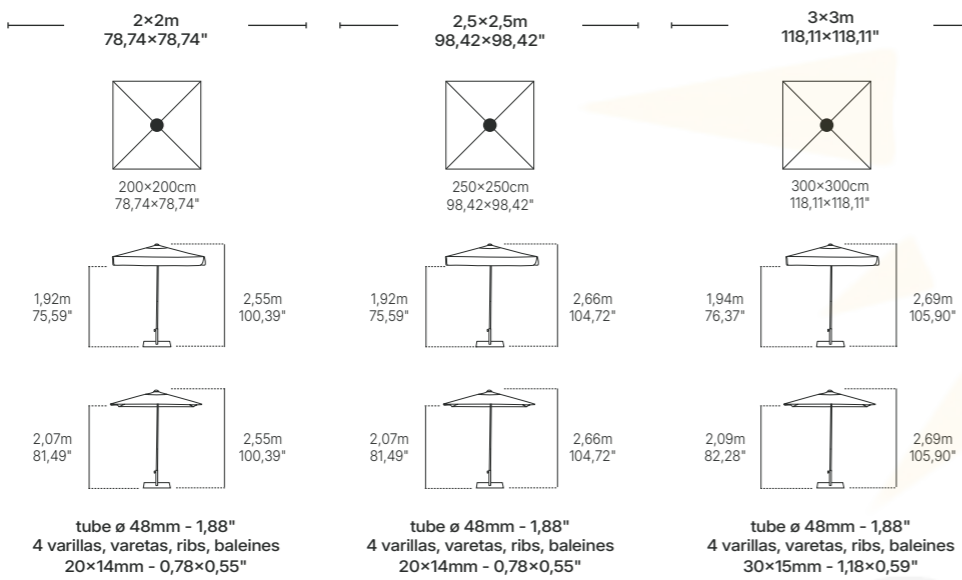

Tejidos/Tecidos/Fabrics/Tissus

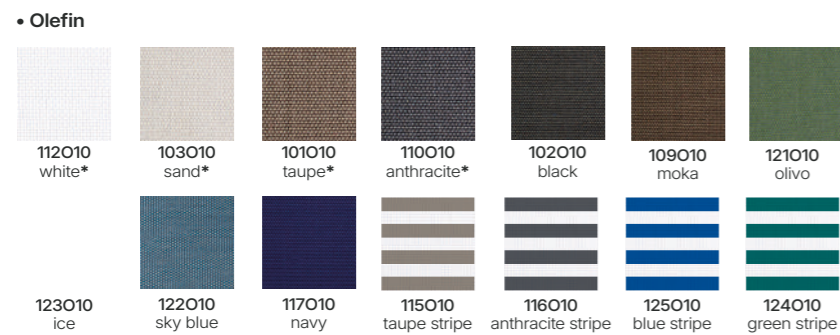

Referencias/Referências/References/Références

Color frame	2x2m - 78,74x78,74"	2,5x2,5m - 98,42x98,42"	3x3m - 118,11x118,11"
<input type="checkbox"/> white	SPAO10C2002740P	SIAO10C2502740P	SGAO10C3002740P
<input checked="" type="checkbox"/> taupe	SPAO10C2002840P	SIAO10C2502840P	SGAO10C3002840P
<input checked="" type="checkbox"/> anthracite	SPAO10C2002640P	SIAO10C2502640P	SGAO10C3002640P
<input type="checkbox"/> white	SPAO10C2002720P	SIAO10C2502721P	SGAO10C3002721P
<input checked="" type="checkbox"/> taupe	SPAO10C2002820P	SIAO10C2502821P	SGAO10C3002821P
<input checked="" type="checkbox"/> anthracite	SPAO10C2002620P	SIAO10C2502621P	SGAO10C3002621P
<input type="checkbox"/> white	SPAD24C2002770P	SIAD24C2502771P	SGAD24C3002771P
<input checked="" type="checkbox"/> taupe	SPAD24C2002870P	SIAD24C2502871P	SGAD24C3002871P
<input checked="" type="checkbox"/> anthracite	SPAD24C2002670P	SIAD24C2502671P	SGAD24C3002671P

Bases / Pieds (Pag. 194/198)

FIX Ø60, FAST CLICK Ø60, BOND Ø60, LOOP Ø60, CANTO Ø60, KUBO MINI

* Los parasoles white/white, taupe/taupe, taupe/sand y antracita/antracita son Puretí. Os guarda sois branco/branco, taupe/taupe, taupe/sand e Antracita/Antracita são. Parasols white/white, taupe/taupe, taupe/sand and anthracite/anthracite are Puretí. Les parasols blanc/blanc, taupe/taupe, taupe/sand et Anthracite/anthracite sont Puretí.

flexo

3x3m-118,11x118,11"



flexo



Parasol de aluminio de mastil lateral con inclinación. 8 varillas. Giratorio 360°. Sistema estabilizador. Sin volante y con fugavientos.

Guarda-sol em alumínio de haste lateral com inclinação. 8 varetas. Giratório 360°. Sistema estabilizador. Sem bambelina e com fugaventos.

Aluminium lateral pole parasol with tilt system. 8 ribs. 360° rotatory system. Stabilizer system. Without valance and with airvent.

Parasol mât latéral avec inclinaison. 8 baleines. Rotatif 360°. Système stabilisateur. Sans volant et avec soufflet.

(Cruceta incluida / cruzeta incluida / cross included / croix incluse)



Tamaños/Tamanhos/Sizes/Tailles

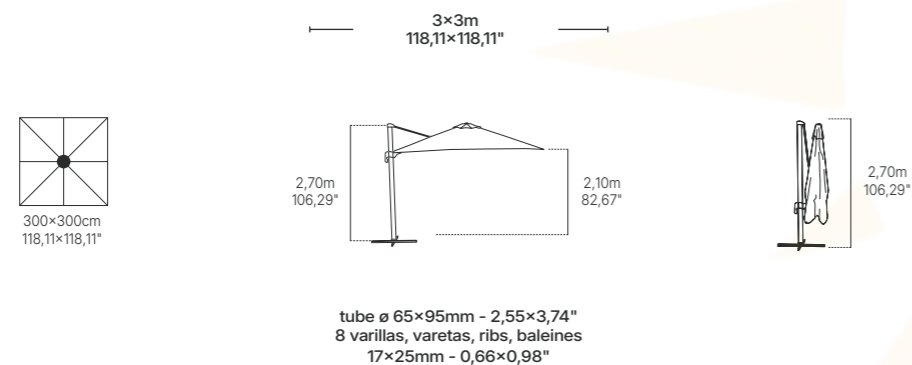

Tejidos/Tecidos/Fabrics/Tissus

• Sunbrella

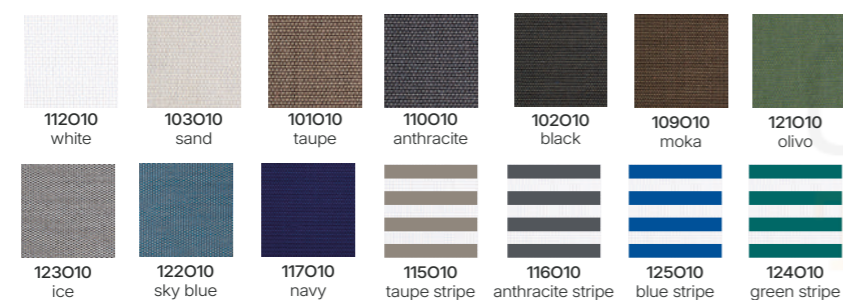

Referencias/Referências/References/Références



Color frame	3x3m - 118,11x118,11"
<input type="checkbox"/> white	SGAO10C3005021P
<input type="checkbox"/> taupe	SGAO10C3005022P
<input type="checkbox"/> anthracite	SGAO10C3005020P

Bases / Pieds (Pag. 194/198)

SLAB, KIT FLEXO

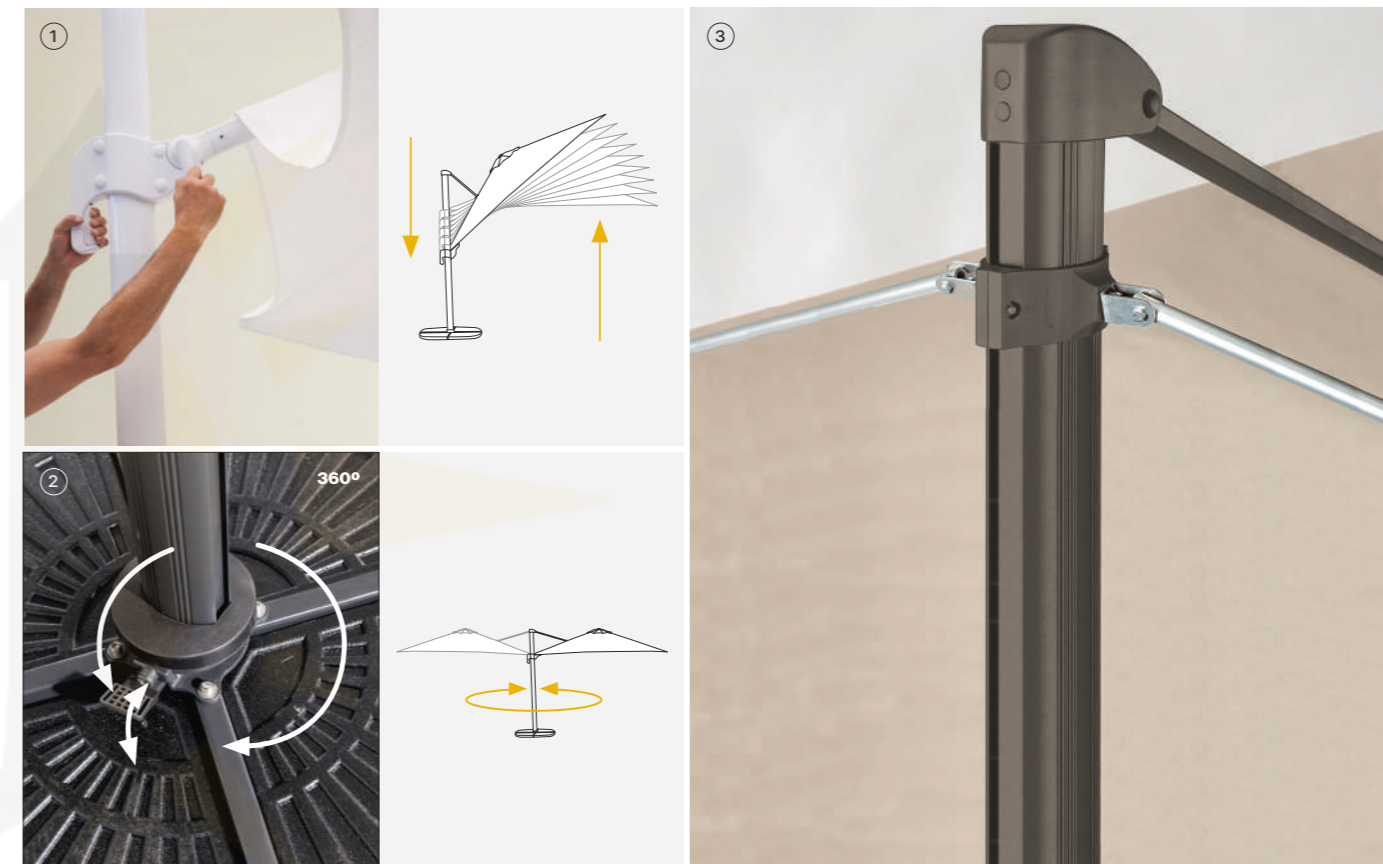

1. Tela multiposición. Tecido multiposições. Multi-position fabric. Tissu multipositions.
2. Sistema de rotación. Sistema de rotação. Rotation System. Système de rotation.
3. Sistema estabilizador. Stabilizer system. Système stabilisateur.



Usar con estas bases. Utilizar com estas bases.
Use with these bases. A utiliser avec ces bases:

SLAB o KIT FLEXO

✓ Sistema de rotación. Sistema de rotação.
Rotation System. Système de rotation.

✓ Más espacio debajo. Mais espaço em baixo. More space below. Plus d'espace ci-dessous.

✗ Ruedas. Rodas. Wheels. Roues.

✗ Sistema de rotación. Sistema de rotação.
Rotation System. Système de rotation.

✓ Más espacio debajo. Mais espaço em baixo. More space below. Plus d'espace ci-dessous.

✓ Ruedas. Rodas. Wheels. Roues.

rio

4x4m-157,48x157,48"

rio

Parasol de aluminio lacado para terrazas grandes. 8 varillas intercambiables. Apertura asistida manivela. Telescópico. Con o sin volante y con fugavientos.

Guarda-sol em alumínio lacado para esplanadas grandes. 8 varetas intercambiáveis. Abertura assistida manivela. Telescópico. Com ou sem bambinela e com fugaventos.

Lacquered aluminium parasol for big terraces. 8 exchangeable ribs. Crank- assisted opening system. Telescopic. With or without valance and with airvent.

Parasol aluminium laqué pour grande terrasse. 8 baleines interchangeables. Ouverture assistée manivelle. Téléscopique. Avec ou sans volant et avec soufflet.

sunbrella™



white



anthracite

Tamaños/Tamanhos/Sizes/Tailles

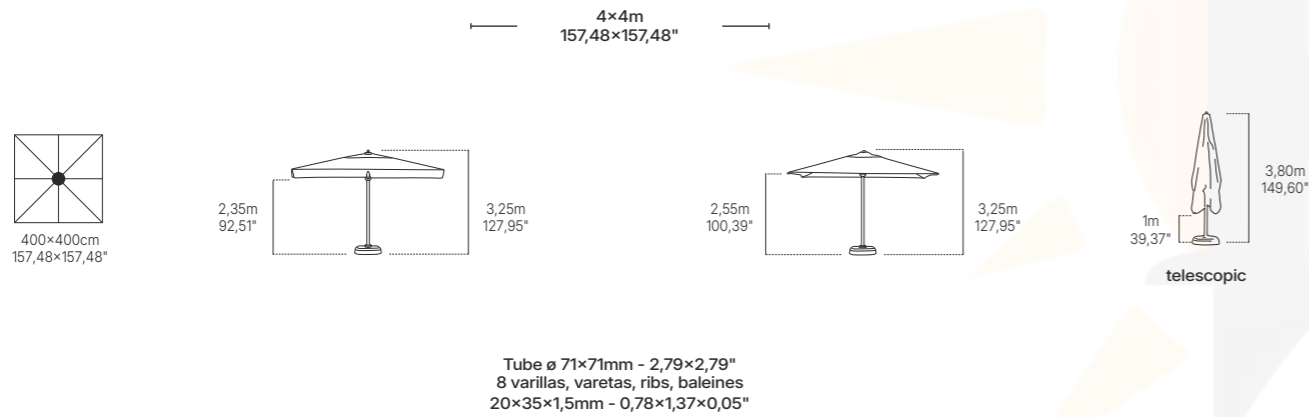

Tejidos/Tecidos/Fabrics/Tissus

• Sunbrella 275 g

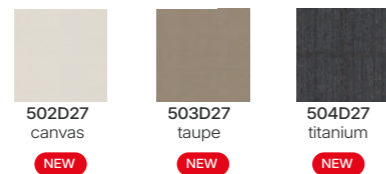

Referencias/Referências/References/Références

<p>sunbrella</p>	Color frame	4x4m - 157,48x157,48"
	<input type="checkbox"/> white	SGAD27C4000340P
<p>sunbrella</p>	<input checked="" type="checkbox"/> anthracite	SGAD27C4000440P
	<input type="checkbox"/> white	SGAD27C4000320P
<p>sunbrella</p>	<input checked="" type="checkbox"/> anthracite	SGAD27C4000420P
	<input type="checkbox"/> white	SGAD27C4000320P

Bases / Pieds (Pag. 194/198)

KIT CROSS RIO, FIX RIO, FAST CLICK RIO, KUBO MAXI

formentera

formentera

Parasol de aluminio lacado. 8 varillas. Apertura por poleas. Sin volante y con fugavientos.
 Guarda-sol em alumínio lacado. 8 varetas. Abertura por roldanas. Sem bambinela e com fugavientos.
 Lacquered aluminium parasol. 8 ribs. Pulley opening system. Without valance and with airvent.
 Parasol aluminium laqué. 8 baleines. Ouverture par poulie. Sans volant et avec soufflet.



Tamaños/Tamanhos/Sizes/Tailles

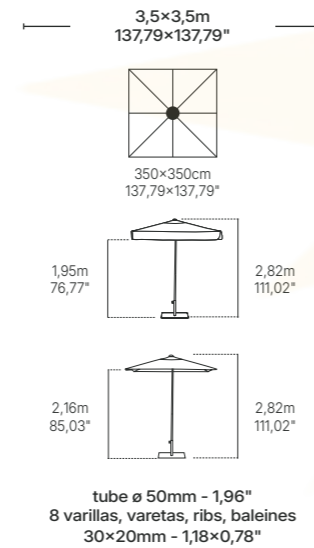
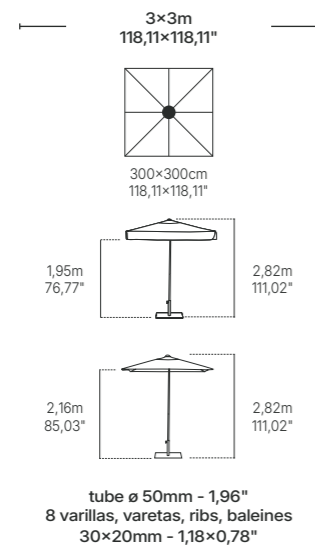

Tejidos/Tecidos/Fabrics/Tissus

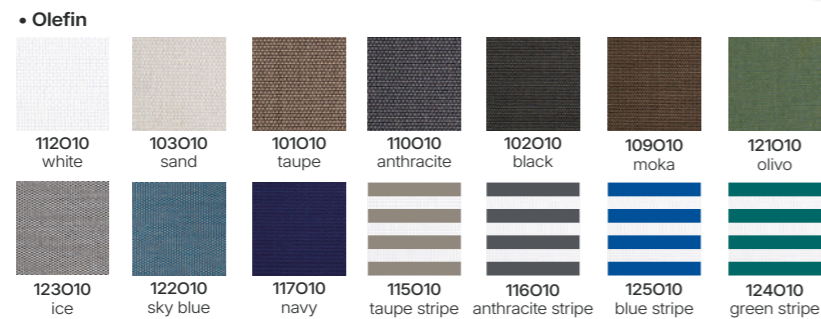

Referencias/Referências/References/Références

	3x3m - 118,11x118,11"	3,5x3,5m - 137,79x137,79"
olefin	SGAO10C3000240P	SGAO10C3500140P
olefin	SGAO10C3000540P	SGAO10C3500340P
olefin	SGAO10C3000220P	SGAO10C3500120P
olefin	SGAO10C3000520P	SGAO10C3500320P

Bases / Pieds (Pag. 194/198)

KIT CROSS, FIX, FAST CLICK, BOND 50 Ø60, LOOP 35 Ø60 (3X3), LOOP 50 Ø60, CANTO Ø60 (3X3), KUBO MAXI (3,5X3,5), KUBO MINI (3X3)

formentera lateral

formentera lateral

Parasol de aluminio lacado de mástil lateral. 5 varillas. Apertura por poleas.
Sin volante y con fugavientos.

Guarda-sol de mastro lateral em alumínio lacado. 5 varetas. Abertura por roldanas.
Sem bambinela e com fugavientos.

Lacquered aluminum side mast parasol. 5 ribs. Pulley
opening system. Without valance and with airvent.

Parasol lateral en aluminium laqué. 5 baleines. Ouverture par poulie.
Sans volant et avec soufflet.

OLEFIN
FIBER
190g



anthracite

Tamaños/Tamanhos/Sizes/Tailles

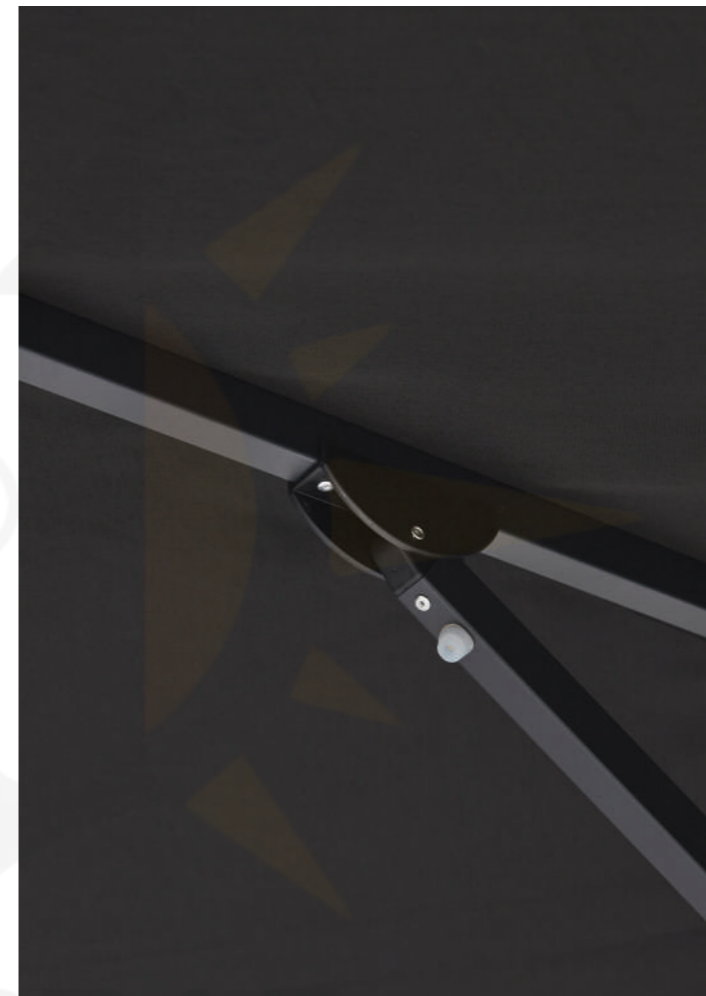
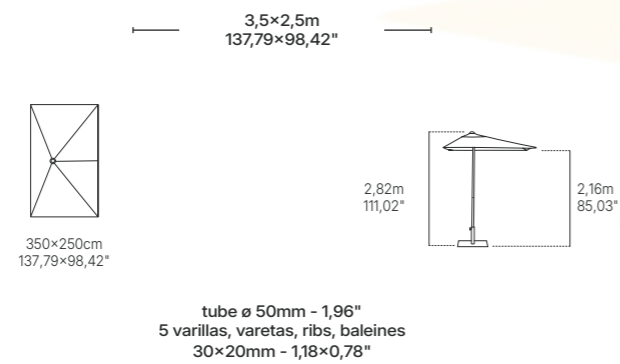

Tejidos/Tecidos/Fabrics/Tissus

• Olefin



103010
sand



110010
anthracite

Referencias/Referências/References/Références



Color frame	3,5x2,5m - 137,79x98,42"
anthracite	SGAO10H3500020P

Bases / Pieds (Pag. 194/198)

FIX, FAST CLICK, BOND 50 Ø60, LOOP 50 Ø60, KUBO MAXI



Parasol de aluminio lacado gris. 8 varillas. Apertura por poleas.
Sin volante y con fugavientos.
Guarda-sol em alumínio lacado cinza. 8 varetas. Abertura por roldanas.
Sem bambinela e com fugaventos.
Grey lacquered aluminium parasol. 8 ribs.
Pulley opening system. Without valance and withairvent.
Parasol aluminium laqué gris.
8 baleines. Ouverture par poulie. Sans volant et avec soufflet.



grey

Tamaños/Tamanhos/Sizes/Tailles

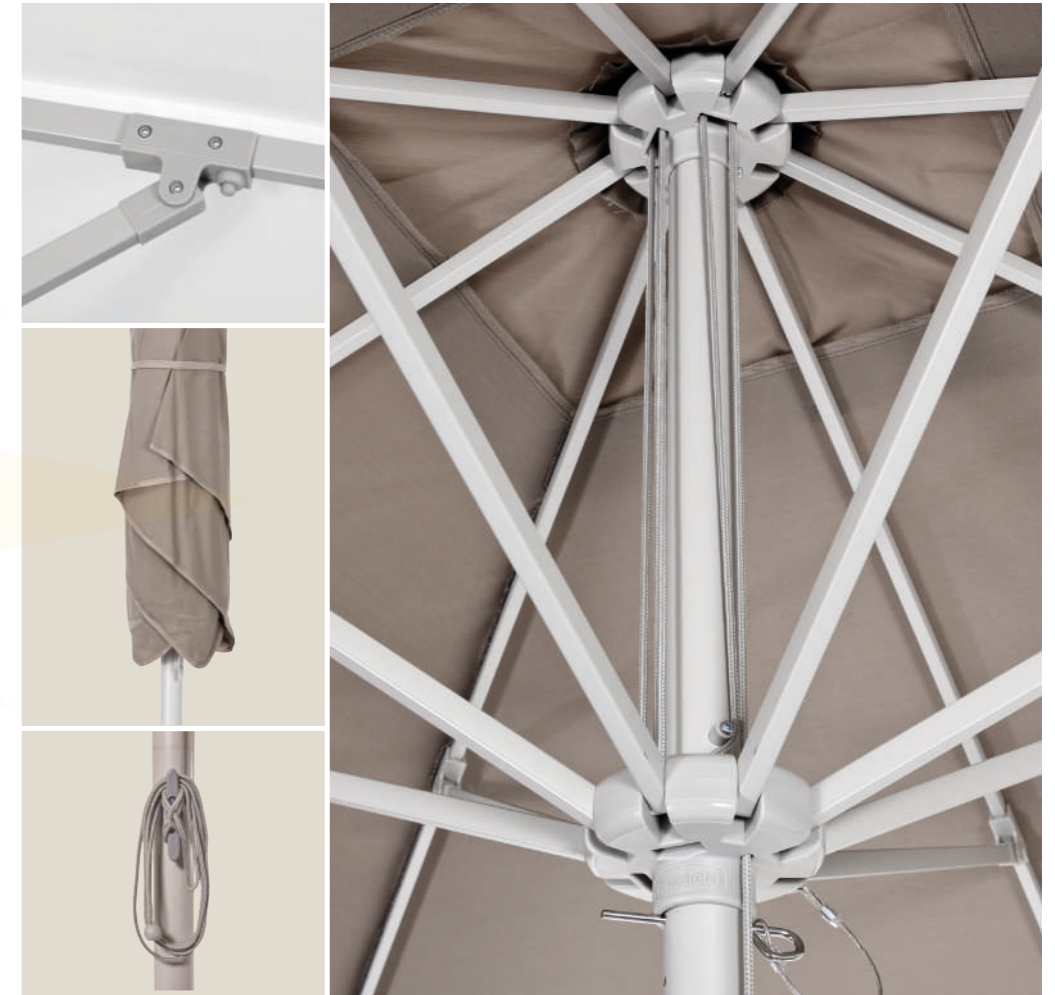
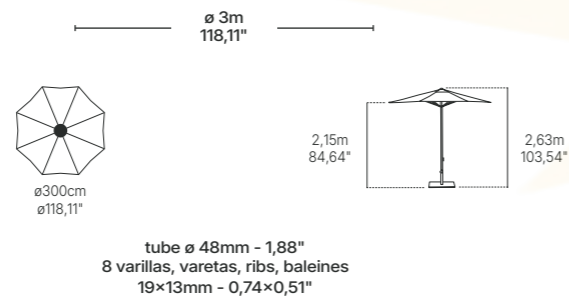

Tejidos/Tecidos/Fabrics/Tissus

• Olefin

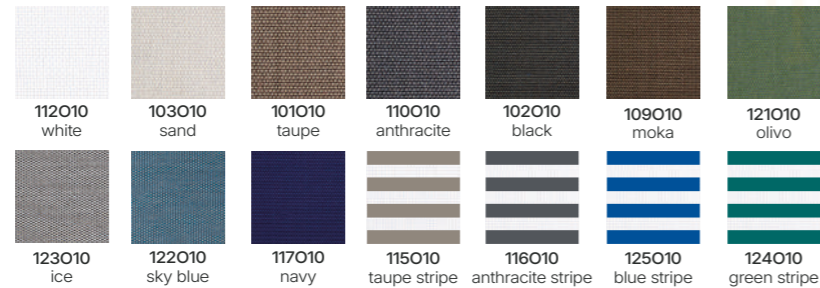

Referencias/Referências/References/Références



Color frame	\varnothing 3m - 118,11"
grey	SIA01003000820P

Bases / Pieds (Pag. 194/198)

FIX, FAST CLICK, BOND \varnothing 60, LOOP \varnothing 60, CANTO \varnothing 60



Parasol de madera de eucalipto barnizada. 8 varillas. Apertura por poleas.
Sin volante y con fugavientos. Madera procedentes de fuentes sostenibles.
Certificado FSC®.

Guarda-sol de madeira de eucalipto envernizada. 8 varetas. Abertura por roldanas.
Sem bambinela e com fugaventos. Madeira proveniente de fontes reforestadas. Certificado FSC®.

Varnished eucalyptus wood parasol. 8 ribs. Pulley opening system. Without valance and with airvent. Wood from reforested sources. FSC® certified.

Parasol bois d'eucalyptus verni. 8 baleines. Ouverture par poulie. Sans volant et avec soufflet. Bois provenant de sources reboisées. Certified FSC®.



Tamaños/Tamanhos/Sizes/Tailles

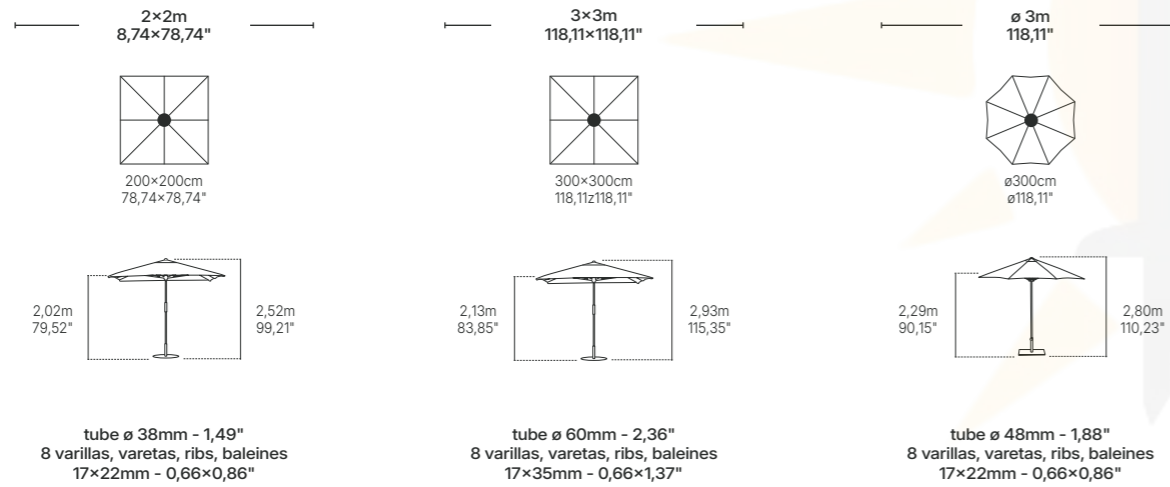

Tejidos/Tecidos/Fabrics/Tissus

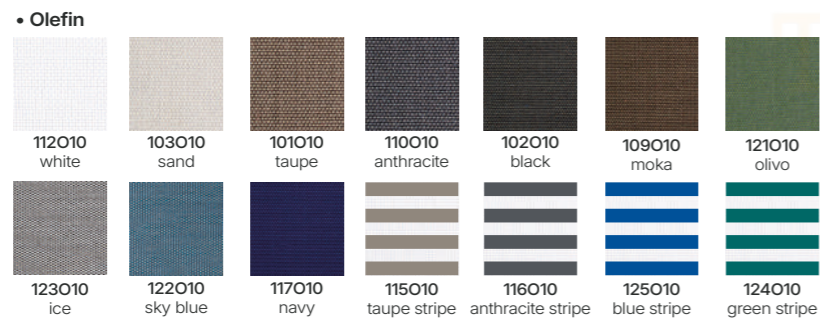

Referencias/Referências/References/Références

Color frame	2x2m - 78,74x78,74"	3x3m - 118,11x118,11"	ø3m - 118,11"
wood	SPM010C2000220P	SGM010C3000220P	SIM01003000720P

Bases / Pieds (Pag. 194/198)

BOND 50 Ø70, LOOP 50 Ø70, CANTO Ø70

madeira

3m-118,11"



R. D. No. SIMO1003000750P

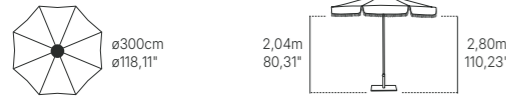

tube ø 48mm - 1,88"
8 varillas, varetas, ribs, baleines
17x22mm - 0,66x0,86"



• Olefin



Parasol de madera de eucalipto barnizada. 8 varillas. Apertura por poleas. Con volante, fleco y fugavientos. Madera procedente de fuentes sostenibles. Certificado FSC®.

Guarda-sol de madeira de eucalipto envernizada. 8 varetas. Abertura por roldanas. Com bambinela, franjas e fugavientos. Madeira proveniente de fontes reflorestadas. Certificado FSC®.

Varnished eucalyptus wood parasol. 8 ribs. Pulley opening system. With valance, fringes and airvent. Wood from reforested sources. FSC® certified.

Parasol bois d'eucalyptus verni. 8 baleines. Ouverture par poulie. Avec volants, franges et soufflet. Bois provenant de sources robisées. Certified FSC®.

Bases / Pieds (Pag. 194/198)

FIX, FAST CLICK, BOND Ø60, LOOP 35 Ø60, LOOP 50 Ø60, CANTO Ø60

palma

2,5m-98,42"



R. D. No. SIAO1002500000P

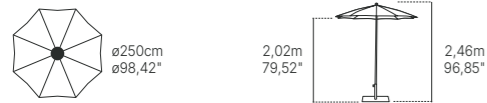

tube ø 40-45mm - 1,57-1,77"
8 varillas, varetas, ribs, baleines
8mm - 0,31"



• Olefin

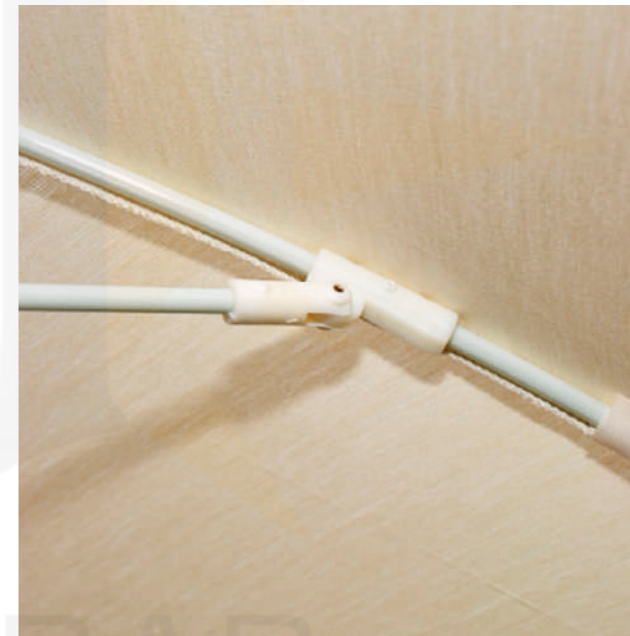
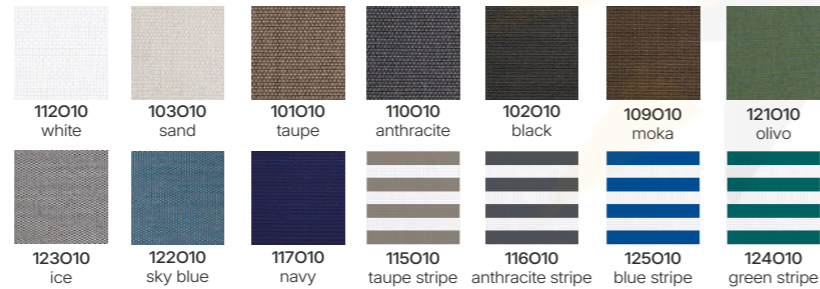

Parasol de aluminio. 8 varillas de fibra de vidrio. Regulable en altura. Sin volante y sin fugavientos. Capito T extrarresistente.

Guarda-sol em alumínio. 8 varetas de fibra de vidro. Regulável em altura. Sem bambinela e sem fugavientos. Tip T extraforte.

Aluminium parasol. 8 fiberglass ribs. Adjustable height. Without valance and without airvent. Extrarresistant T tip.

Parasol aluminium. 8 baleines en fibre de verre. Ajustable en hauteur. Sans volant et sans soufflet. Tip T extra forte.

Bases / Pieds (Pag. 194/198)

FIX, FAST CLICK, BOND Ø60, LOOP 35 Ø60, LOOP 50 Ø60, CANTO Ø60

menorca

2,5m-98,42"



R. D. No. SIAO1002500006P

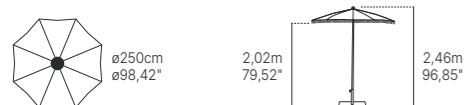

tube ø 40-45mm - 1,57-1,77"
8 varillas, varetas, ribs, baleines
8mm - 0,31"



• Olefin



Parasol de aluminio. 8 varillas de fibra de vidrio. Regulable en altura. Sin volante y sin fugavientos. Con flecos. Capito T extrarresistente.

Guarda-sol em alumínio. 8 varetas de fibra de vidro. Regulável em altura. Sem bambinela e sem fugavientos. Com franjas. Tip T extraforte.

Aluminium parasol. 8 fiberglass ribs. Adjustable height. Without valance and without airvent. Whit fringes. Extrarresistant T tip.

Parasol aluminium. 8 baleines en fibre de verre. Ajustable en hauteur. Sans volant et sans soufflet. Avec franges. Tip T extra forte.

Bases / Pieds (Pag. 194/198)

FIX, FAST CLICK, BOND Ø60, LOOP Ø60, CANTO Ø60

tenerife

INOX 2m-78,74"



R. D. No. SPIO10D2005310P

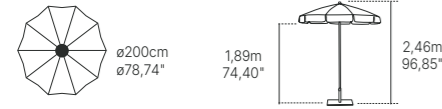

Tube ø 28-35mm - 1,10-1,37"
10 varillas, varetas, ribs, baleines
6mm - 0,23"

• Olefin

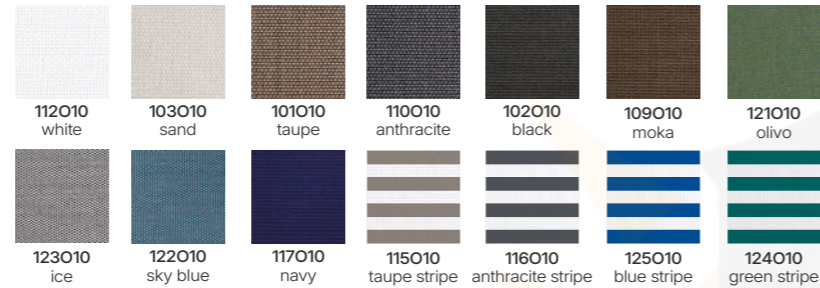

Parasol de INOX con inclinación. 10 varillas de fibra de vidrio. Regulable en altura. Con volante y sin fugavientos. Capito T extrarresistente.
Guarda-sol em INOX com inclinação. 10 varetas de fibra de vidro. Regulável em altura. Com bambelina e sem fugaventos. Tip T extraforte.
INOX parasol with tilt system. 10 fiberglass ribs. Adjustable height. With valance and without airvent. Extrarresistant T tip.
Parasol INOX avec inclinaison. 10 baleines en fibre de verre. Ajustable en hauteur. Avec volants et sans soufflet. Tip T extra forte.

Bases / Pieds (Pag. 194/198)
BOND 35 ø45, LOOP 18 ø45, LOOP 35 ø45, FIT

ons

SAND 2m-78,74"



R. D. No. SPA010D2000110T

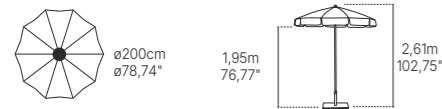

Tube ø 29-32mm - 1,14-1,25"
10 varillas, varetas, ribs, baleines
6mm - 0,23"

• Olefin



Parasol de aluminio lacado sand. 10 varillas de fibra de vidrio. Regulable en altura. Con volante y sin fugavientos. Capito T extrarresistente.
Guarda-sol em alumínio lacado sand. 10 varetas de fibra de vidro. Regulável em altura. Com bambelina e sem fugaventos. Tip T extraforte.
Sand lacquered aluminium parasol. 10 fiberglass ribs. Adjustable height. With valance and without airvent. Extrarresistant T tip.
Parasol aluminium laqué sand. 10 baleines en fibre de verre. Ajustable en hauteur. Avec volants et sans soufflet. Tip T extra forte.

Bases / Pieds (Pag. 194/198)
BOND 35 ø45, LOOP 18 ø45, LOOP 35 ø45, FIT

new toscana

SAND 2m-78,74"



R. D. No. SPA010D2000150T

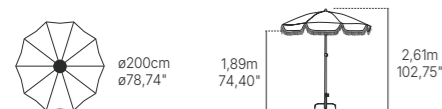

Tube ø 29-32mm - 1,14-1,25"
10 varillas, varetas, ribs, baleines
6mm - 0,23"

• Olefin



Parasol de aluminio lacado sand. 10 varillas de fibra de vidrio. Regulable en altura. Con flecos. Con volante y sin fugavientos. Capito T extrarresistente.
Guarda-sol em alumínio lacado sand. 10 varetas de fibra de vidro. Regulável em altura. Com franjas. Com bambelina e sem fugaventos. Tip T extraforte.
Sand lacquered aluminium parasol. 10 fiberglass ribs. Adjustable height. With fringes. With valance and without airvent. Extrarresistant T tip.
Parasol aluminium laqué sand. 10 baleines en fibre de verre. Ajustable en hauteur. Avec franges et volants et sans soufflet. Tip T extra forte.

Bases / Pieds (Pag. 194/198)
BOND 35 ø45, LOOP 18 ø45, LOOP 35 ø45, FIT

manila

2m - 78,74"

UPF50+

R. D. No. SPSZ02D2000001T

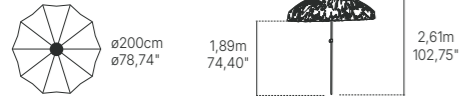

Tube ø 29-32mm - 1,14-1,25"
10 varillas, varetas, ribs, baleines
6mm - 0,23"



Parasol de acero imitación madera natural. 10 varillas de fibra de vidrio. Regulable en altura. Con volante y sin fugavientos.

Guarda-sol em aço imitação madeira natural. 10 varetas de fibra de vidro. Regulável em altura. Com bambelina e sem fugavientos.

Natural wood finishing steel parasol. 10 fiberglass ribs. Adjustable height. With valance and without airvent.

Parasol acier finition bois naturel. 10 baleines en fibre de verre. Ajustable en hauteur. Avec volants et sans soufflet.

Bases / Pieds (Pag. 194/198)

BOND 35 ø45, LOOP 18 ø45, LOOP 35 ø45, FIT

fundaparasol

Capa Guarda-Sol - Parasol Cover - Couverture Parasol

POLYESTER
210g

WATER PROOF



→ Ref. 31p18c40000
Rio 400×4000

→ Ref. 31p18c30000
Formentera 300×300
Vigo 300×300 - Java 300×300

→ Ref. 31p18c35000
Formentera 350×350
Flexo 300×300

→ Ref. 31p18c25000
Eolo - Vigo - Java



sunbrella

Tejido elaborado con fibras acrílicas tintadas en masa, desde el núcleo del hilo, para garantizar una alta resistencia a la decoloración frente a la radiación UV. Su composición ofrece un equilibrio perfecto entre resistencia y flexibilidad, ideal para parasoles de uso intensivo. Ofrece una protección solar hasta UPF 50+, bloqueando más del 95% de los rayos UV, y presenta una solidez a la luz de 4-5/5 según la norma ISO 105 B04. Su acabado repelente al agua, resistente al moho y a las manchas, libre de compuestos PFAS, protege el tejido y facilita un mantenimiento sencillo y sostenible.

Garantía de 5 años frente a la abrasión, la aparición de bolitas, la decoloración y la pérdida de tensión.

Tecido elaborado com fibras acrílicas tingidas em massa, desde o núcleo do fio, para garantir uma elevada resistência à descoloração causada por raios UV. A sua composição oferece um equilíbrio perfeito entre resistência e flexibilidade, ideal para guarda-sóis de uso intensivo. Oferece uma proteção solar até UPF 50+, bloqueando mais de 95% dos raios UV, e apresenta uma solidez à luz de 4-5/5 segundo a norma ISO 105 B04. O seu acabamento repelente à água, resistente ao bolor e às manchas, livre de compostos PFAS, protege o tecido e facilita uma manutenção simples e sustentável.

Inclui 5 anos de garantia contra abrasão, borbotos, descoloração e perda de tensão.

Fabric crafted from acrylic fibres, dyed thoroughly within the core of the yarn to ensure high resistance caused by UV radiation. Its composition provides a perfect balance between strength and flexibility, ideal for intensive-use parasols. It offers up to UPF 50+ solar protection, blocking more than 95% of UV rays, and has a lightfastness rating of 4-5/5 according to ISO 105 B04. Its water-repellent, mould- and stain-resistant finish, free from PFAS compounds, protects the fabric and ensures easy and sustainable maintenance.

Comes with a 5-year warranty against abrasion, pilling, fading and tension loss.

Tissé exclusivement à partir de fibres acryliques Sunbrella® teint dans la masse, colorées du cœur à la surface du fil, garantissant une grande résistance à la décoloration due aux rayons UV. Sa composition garantit un équilibre parfait entre résistance et souplesse, ce qui en fait un choix idéal pour les parasols destinés à un usage intensif. Grâce à sa protection solaire jusqu'à UPF 50+, il bloque plus de 95 % des rayons UV et a une résistance à la lumière de 4-5, 5 selon la norme ISO 105 B04. Grâce à son traitement déperlant, qui est résistant à la moisissure et aux taches, sans composés PFAS, le tissu est protégé et permet un entretien simple et durable.

Il bénéficie d'une garantie de 5 ans contre l'abrasion, le boulochage, la décoloration et la perte de tension.



• Eolo

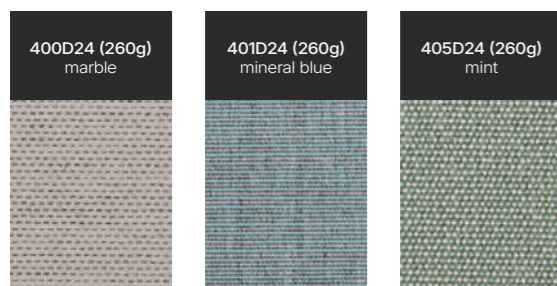

• Sunbrella 260 g

• Rio

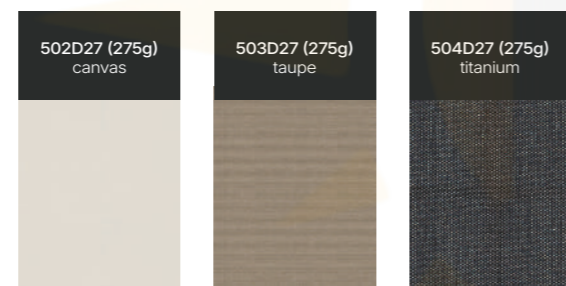

NEW FABRIC

NEW FABRIC

NEW FABRIC

nautic

(Ibiza, Nana & Marine colchón/colchão/mattress/matelas)

Tejido repelente al agua, confeccionado en PCV y polyester. Gran resistencia a los rayos UV (Solidez a la luz >7). Antibacteriano y antimoho. Certificado BLUEWORLD. Tejido repelente à água, fabricado em PCV e poliéster. Elevada resistência aos raios UV (solidez à luz >7). Anti-bacteriano e anti-bolor. Certificado BLUEWORLD.

Water repellent fabric, made of PCV and polyester. High UV resistance (Light fastness >7). Antibacterial and anti-mould. BLUEWORLD certified.

Tissu hydrofugé, composé de PCV et de polyester. Grande résistance aux rayons UV (solidité à la lumière >7). Anti-bactérien et anti-moisissure. Certifié BLUEWORLD.

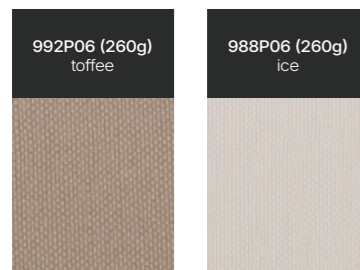

BLUEWORLD
HUMAN CARE TECHNOLOGY



Respects the Environment
Respektiert die Umwelt
Respeto el Medio Ambiente



SOLUTION DYED - COLOUR FASTNESS: 7-8/8 - 100% RECYCLABLE

olefin

Alta solidez de los colores a la radicación UV (7/8). Se trata de un tejido fabricado con hilo de polipropileno que ha sido tintado en masa, en su proceso inicial. Esto le otorga una gran resistencia a la luz solar ya que el color queda fijado en el hilo del tejido con mayor intensidad que en otros procesos. Dependiendo del color varía la durabilidad de la intensidad de los colores a la exposición solar.

Certificación UV standard 801 con la puntuación UPF 80, que garantiza la protección de la piel de los efectos nocivos de los rayos UV.

Resistente a las manchas - 100% reciclable.

High resistance of colours to UV radiation (7/8). The fabric is made from polypropylene fabric mass-dyed during the initial process. This provides high resistance to sunlight because the colour is set in the thread of the fabric more intensely than in other processes. Depending on the color, the durability of color intensity varies when exposed to sunlight.

UV standard 801 certification rating UPF 80, that guarantees skin protection against nocive effects of UV rays on the skin.

Stain resistance - 100% recyclable.

Alta resistência das cores face à radiação UV. Ao ser um tecido fabricado com fio de polipropileno tingido em massa no seu processo inicial, esta característica confere-lhe uma maior resistência à luz solar o que se deve essencialmente ao facto de a cor permanecer fixa ao fio com maior intensidade do que em outros processos de pigmentação. A durabilidade da intensidade das cores, varia dependendo da cor e da exposição solar.

Certificação UV standard 801 com factor de proteção UPF 80, que garante a proteção da pele dos efeitos nocivos dos raios UV.

Anti-manchas - 100% reciclável.

Haute résistance des couleurs face à la radiation solaire. Il s'agit ici d'une toile fabriquée à partir d'un fil en polypropylène qui a été teinté en masse, depuis son processus initial. Ceci lui confère une haute résistance à la lumière solaire, étant donné que la teinte reste fixée sur le fil avec une plus grande intensité en comparaison avec d'autres processus de pigmentation. Selon la couleur choisie, la durabilité de l'intensité de celle-ci varie en fonction de l'exposition au soleil.

Certification UV standard 801 avec un facteur de protection UPF 80, qui garantie une protection de la peau face aux effets nocifs des rayons UV.

Résistante toile aux tâches - 100% recyclable.

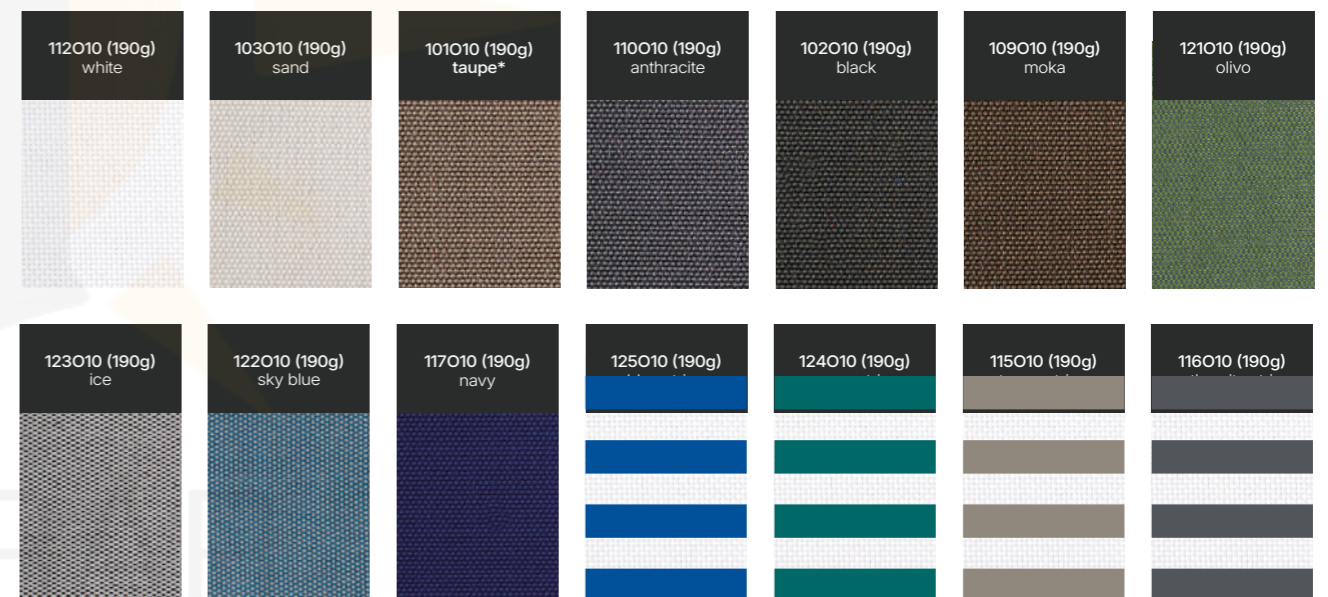

Disponemos de un tejido de poliéster 100% tintado en masa para pedidos con logotipo.

Temos um tecido 100% poliéster tingido em massa para pedidos com logotipo.

We have a 100% mass-dyed polyester fabric for orders with a logo.

Nous avons un tissu 100% polyester teint dans la masse pour les commandes avec logo.

* Solidez 7-no recomendado para zonas de alta radiación solar. Solidez 7. Não recomendado para áreas de alta radiação solar.

Color fastness rating 7. Not recommended for areas with excessive sunlight exposure. Sa solidité est de 7. Déconseillé pour des zones à fort rayonnement solaire.

slab

(hormigón/polipropileno-betão/polipropileno-concrete/polypropylene-béton/polypropylène)

→ Flexo

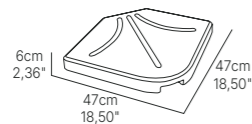

BEC047BC03
white



BEC047TP00
taupe



BEC047NG02
anthracite

25kg-55,11lb
100kg-220,46lb (4 U)

- Peso de hormigón/polipropileno.
- Peso em betão/polipropileno.
- Concrete/polypropylene weight.
- Poids en béton/polypropylène

kit flexo

(hierro/hormigón/polipropileno-ferro/betão/polipropileno-iron/concrete/polypropylene)

→ Flexo

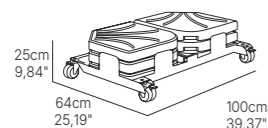

BSH990BCK
white



BSH990TPK
taupe



BSH990ANK
black

177kg-390,22lb

- Base lateral de hierro cincado con ruedas y pesos de hormigón/polipropileno. *El sistema de rotación del parasol Flexo no vale para esta base.
- Base lateral em ferro zincado com rodas e pesos em betão/polipropileno. *O sistema de rotação do guarda-sol Flexo não pode ser utilizado para esta base.
- Zinc-plated iron side base with castors and concrete/polypropylene weights. *The rotation system of the Flexo parasol is not suitable for this base.
- Base latérale en fer zingué avec roulettes et poids en béton/polypropylène. *Le système de rotation du parasol Flexo n'est pas adapté à cette base.

kit cross

(hierro/hormigón-ferro/betão-iron/concrete-fer/béton)

kit cross

→ Formentera

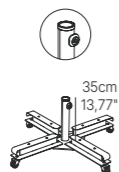
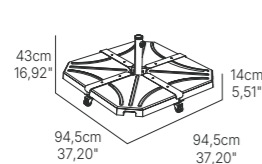

BSRDBC6001K
CROSS - white

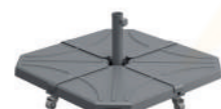

BSRDAN6001K
CROSS - anthracite



BSRDTP6001K
CROSS - taupe

118kg-260,45lb
tube ø60mm-2,36"

- Base de hierro cincado con ruedas y pesos de hormigón/polipropileno.
- Base em ferro zincado com rodas e pesos em betão/polipropileno.
- Zinc-plated iron base with castors and concrete/polypropylene weights.
- Base en fer zingué avec roulettes et poids en béton/polypropylène.

kit cross rio

→ Rio

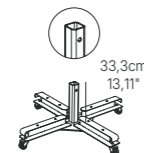
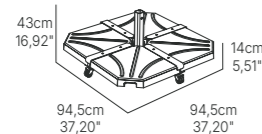

BSRDBC6010K
CROSS RIO - white



BSRDAN6010K
CROSS RIO - anthracite

118kg-260,45lb
tube ø60mm-2,36"

- Base de hierro cincado con ruedas y pesos de hormigón/polipropileno.
- Base em ferro zincado com rodas e pesos em betão/polipropileno.
- Zinc-plated iron base with castors and concrete/polypropylene weights.
- Base en fer zingué avec roulettes et poids en béton/polypropylène.

kubo NEW

(acero lacado/polímeros reciclados-aço lacado/polímeros reciclados-lacquered steel/recycled polymer-acier laqué/polymères)

→ Rio

kubo maxi

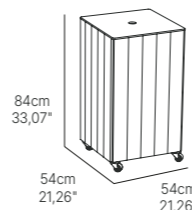

BPC082MK6000 - moka
BPC082MK6010 - rio

80kg-176,37lb
base pole ø60mm-2,36"

- Base de parasol rellenable. Estructura de acero lacado y tablas de polímeros reciclados post-consumo. Tablero extraíble. Con ruedas.
- Base de guarda-sol com espaço para enchimento. Estrutura de aço lacado e tábuas de polímeros reciclados pós-consumo. Tampa/mesa removível. Com rodas.
- Fillable parasol base. Lacquered steel structure and post-consumer recycled polymer boards. Removable tabletop. With wheels.
- Base de parasol remplissable. Structure en acier laqué et planches en polymères recyclés post-consommation. Plateau amovible. Avec roulettes.

kubo mini

→ Platto
Eolo
Formentera



BPC065MK6000 - moka
BPC065MK6010 - rio

43kg-9479lb
base pole ø60mm-2,36"

- Base de parasol rellenable. Estructura de acero lacado y tablas de polímeros reciclados post-consumo. Tablero extraíble. Con ruedas.
- Base de guarda-sol com espaço para enchimento. Estrutura de aço lacado e tábuas de polímeros reciclados pós-consumo. Tampa/mesa removível. Com rodas.
- Fillable parasol base. Lacquered steel structure and post-consumer recycled polymer boards. Removable tabletop. With wheels.
- Base de parasol remplissable. Structure en acier laqué et planches en polymères recyclés post-consommation. Plateau amovible. Avec roulettes.

fix

(hierro-ferro-iron-fer)

→ Platto
Eolo
Formentera
Formentera Lateral
Vigo
Java
Madeira
Palma
Menorca

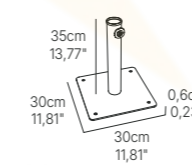

BSC310GR6000
FIX - grey



BSC310BC6000
FIX - white



BSC310TP6000
FIX - taupe



BSC310AN6000
FIX - anthracite

6kg-13,23lb
tube ø60mm-2,36"

- Base de hierro con cataforesis para atornillar a suelo.
- Base em ferro com cataforese para aparafusar ao chão.
- Cataphoresis iron base for bolting to the floor.
- Base en fer cataphorisée à fixer au sol.

fix rio

→ Rio

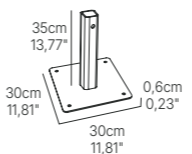

BSC310BC6010
FIX RIO - white



BSC310AN6010
FIX RIO - anthracite

6kg-13,23lb
tube ø60mm-2,36"

- Base de hierro con cataforesis para atornillar a suelo.
- Base em ferro com cataforese para aparafusar ao chão.
- Cataphoresis iron base for bolting to the floor.
- Base en fer cataphorisée à fixer au sol.

fast click

(inox)

fast click

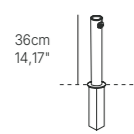

**BIFC60310 - ø60
FAST CLICK
inox**

→ Platto
Eolo
Formentera
Formentera Lateral
Vigo
Java
Madeira
Palma
Menorca

fast clickrio

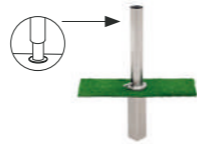
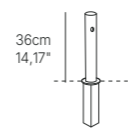

**BIFC63500
FAST CLICK RIO
inox**

→ Rio

**4kg-8,82lb
Tube ø60mm-2,36"**

- Base de acero inoxidable para incrustar en el suelo.
- Base em aço inox para embutir no pavimento.
- **Stainless steel base for embedding in the floor.**
- Base en acier inoxydable pour scellage au sol.

**4kg-8,82lb
Tube ø60mm-2,36"**

- Base de acero inoxidable para incrustar en el suelo.
- Base em aço inox para embutir no pavimento.
- **Stainless steel base for embedding in the floor.**
- Base en acier inoxydable pour scellage au sol.

bond

(hormigón/polipropileno-betão/polipropileno-concrete/polypropylene-béton/polypropylène)

bond35



→ Tubo ø45:
Tenerife
Ons
Toscana
Manila

→ Tubo ø60:
Platto
Eolo
Vigo
Java
Madeira
Palma
Menorca

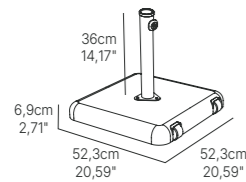

**BPC523GR4500 ø45
BPC523GR6000 ø60**
grey



**BPC523BC4500 ø45
BPC523BC6000 ø60**
white



**BPC523TP4500 ø45
BPC523TP6000 ø60**
taupe



**BPC523AN4500 ø45
BPC523AN6000 ø60**
anthracite



BPC523OX6000 ø60
rust

NEW

**35kg-77,16lb
Tube ø45mm-1,77" / ø60mm-2,36"**

- Base de hormigón con carcasa de polipropileno, tubo de acero lacado con tratamiento antióxido (cataforesis), tornillería de acero inoxidable y ruedas.
- Base de betão com revestimento em polipropileno, tubo em aço lacado com tratamento anti-ferrugem (cataforese), parafusos em aço inoxidável e com rodas.
- **Concrete base with polypropylene casing, anti-rust treated (cataphoresis) coated steel tubing, castors and stainless steel screws.**
- Base en béton revêtit de polypropylène, tube en acier laqué avec traitement antirouille (cataphorèse), vis et roues en acier inoxydable.



bond 50

→ Tubo ø70
Java

→ Tubo ø60:
Platto
Eolo
Formentera
Formentera Lateral
Vigo
Java
Madeira
Palma
Menorca

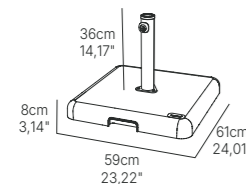

BPC590GR6000
grey



BPC590BC6000
white



BPC590TP6000
taupe



BPC590AN6000
anthracite

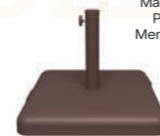

**BPC590OX6000 ø60
BPC590OX7000 ø70**
rust

NEW

**50kg-110,23lb
Tube ø70mm-2,76" / ø60mm-2,36"**

- Base de hormigón con carcasa de polipropileno, tubo de acero lacado con tratamiento antióxido (cataforesis), tornillería de acero inoxidable y ruedas.
- Base de betão com revestimento em polipropileno, tubo em aço lacado com tratamento anti-ferrugem (cataforese), parafusos em aço inoxidável e com rodas.
- **Concrete base with polypropylene casing, anti-rust treated (cataphoresis) coated steel tubing, castors and stainless steel screws.**
- Base en béton revêtit de polypropylène, tube en acier laqué avec traitement antirouille (cataphorèse), vis et roues en acier inoxydable.



loop

(hierro-ferro-iron-fer)

loop 18

(estándar-standard)

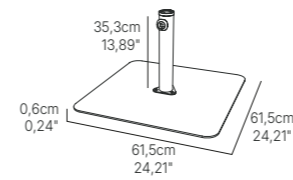

**BSC615BC4500 ø45
BSC615BC6000 ø60**
white



**BSC615TP4500 ø45
BSC615TP6000 ø60**
taupe

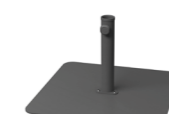

**BSC615AN4500 ø45
BSC615AN6000 ø60**
anthracite

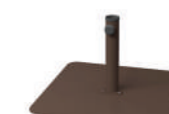

**BSC615OX4500 ø45
BSC615OX6000 ø60**
rust

→ Tubo ø45:
Tenerife
Ons
Toscana
Manila

→ Tubo ø60:
Platto
Eolo
Vigo
Java
Madeira

loop 18

(con crucetas y tacos/ruedas opcionales-com cruzetas e calços/rodas opcionais-with crosspieces and blocks/optional wheels-avec des croisillons et des cales/roues en option)

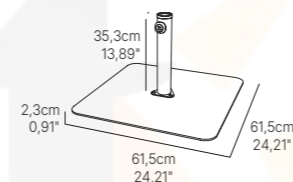

**BSC615BC4502 ø45
BSC615BC6002 ø60**
white



**BSC615TP4500 ø45
BSC615TP6000 ø60**
taupe



**BSC615AN4502 ø45
BSC615AN6002 ø60**
anthracite



**BSC615OX4502 ø45
BSC615OX6002 ø60**
rust

**18kg-39,68lb
Tube ø45mm-1,77" / ø60mm-2,36"**

- Base de hierro con tratamiento antióxido (cataforesis). Tornillería en acero inoxidable.
- Base de ferro con tratamento anti-ferrugem (cataforese). Parafusos em aço inoxidável.
- **Iron base with anti-rust treatment (cataphoresis). Stainless steel screws.**
- Base en fer avec traitement antirouille (cataphorèse). Vis en acier inoxydable.

loop 35

(con tacos y ruedas-com tacos e rodas-with cleats and wheels-avec crampons et roues)

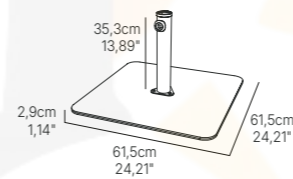

**BSC615BC4512 ø45
BSC615BC6012 ø60**
white



**BSC615TP4512 ø45
BSC615TP6012 ø60**
taupe

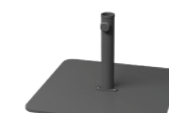

**BSC615AN4512 ø45
BSC615AN6012 ø60**
anthracite

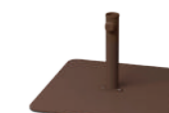

**BSC615OX4512 ø45
BSC615OX6012 ø60**
rust

→ Tubo ø45:
Tenerife
Ons
Toscana
Manila

→ Tubo ø60:
Platto
Eolo
Vigo
Java
Madeira
Palma
Menorca

**35kg-77,16lb
Tube ø45mm-1,77" / ø60mm-2,36"**

- Base de hierro con tratamiento antióxido (cataforesis). Tornillería en acero inoxidable.
- Base de ferro con tratamento anti-ferrugem (cataforese). Parafusos em aço inoxidável.
- **Iron base with anti-rust treatment (cataphoresis). Stainless steel screws.**
- Base en fer avec traitement antirouille (cataphorèse). Vis en acier inoxydable.

loop 50

(con tacos y ruedas-com tacos e rodas-with cleats and wheels-avec crampons et roues)

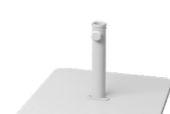
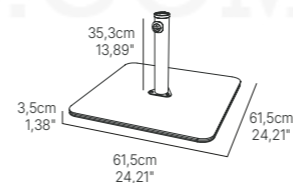

BSC615BC6022 ø60
white

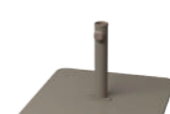

BSC615TP6022 ø60
taupe

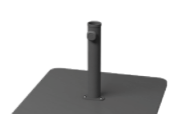

BSC615AN6022 ø60
anthracite

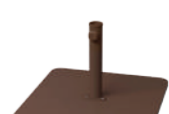

**BSC615BX6022 ø60
BSC615OX7022 ø70**
rust

→ Tubo ø70:
Java

→ Tubo ø60:
Platto
Eolo
Formentera
Formentera Lateral
Vigo
Java
Madeira
Palma
Menorca

**50kg-110,23lb
Tube ø70mm-2,76" / ø60mm-2,36"**

- Base de hierro con tratamiento antióxido (cataforesis). Tornillería en acero inoxidable.
- Base de ferro con tratamento anti-ferrugem (cataforese). Parafusos em aço inoxidável.
- **Iron base with anti-rust treatment (cataphoresis). Stainless steel screws.**
- Base en fer avec traitement antirouille (cataphorèse). Vis en acier inoxydable.

MO-SIE41K (kit 4 U/)
Rueda con freno
Roda com travão
Wheels with brake
Roue avec frein

canto

(hierro-ferro-iron-fer)

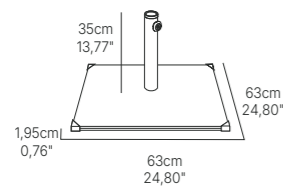

BSC625GR6010 ø60 grey
BSC625BC6010 ø60 white
BSC625TP6010 ø60 taupe
BSC625AN6010 ø60 anthracite
BSC625OX6010 ø60 rust

→ Tubo ø60:
Platto
Eolo
Formentera
Vigo
Java
Madeira
Palma
Menorca

→ Tubo ø70:
Java

37kg-81,57lb
Tubo ø60mm-2,36" - ø70mm-2,75"

- Base de doble chapa de hierro. Cantoneras de acero inoxidable para separar la chapa del suelo. Ruedas con freno. Accesorio: Ruedas con freno.
- Base da placa dupla em ferro. Cantos em aço inoxidável para separar a placa do chão. Acessório: Rodas com freio.
- Double iron plate base. Stainless steel corners to separate the plate from the floor. Accessory: Wheels with brake.
- Double base en fer. Coins en acier inoxydable pour séparer la plaque du sol. Accessoire: Roues avec frein.



MO-SIE41K (kit 4 U/)
Rueda con freno
Roda com travão
Wheels with brake
Roue avec frein

fit

(hierro-ferro-iron-fer)

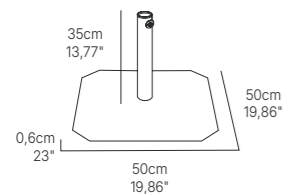

BSO500GR4503 ø45 grey
BSO500BC4501 ø45 white
BSO500OX4500 ø45 rust

→ Tubo ø45:
Tenerife
Ons
Toscana
Manila

12kg-26,45lb
Tubo ø40mm-1,57" - ø45mm1,77"

- Base octogonal de hierro.
- Base de ferro octogonal.
- Octagonal iron base.
- Base octogonale en fer.

tee NEW

(accesorio mesas para bases bond y loop: Tubo 60ø)

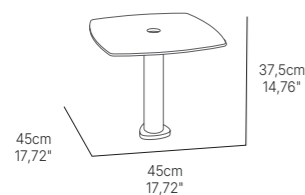

SAC045TEEBC white
SAC045TEETP taupe
SAC045TEEAN anthracite

→ Tubo ø60:
Platto
Eolo
Vigo
Madeira

3kg-6,61lb
Base pole ø60mm-2,36"

- Accesorio de mesa baja incorporable a bases Loop, Bond y Canto. Aluminio Lacado.
- Acessório de mesa baixa, adaptável às bases Loop, Bond e Canto. Alumínio lacado.
- Low table accessory, suitable for the Loop, Bond and Canto bases. Lacquered aluminium.
- Accessoire de table basse, compatible avec les bases Loop, Bond et Canto. Aluminium laqué.



polypropylene



compact

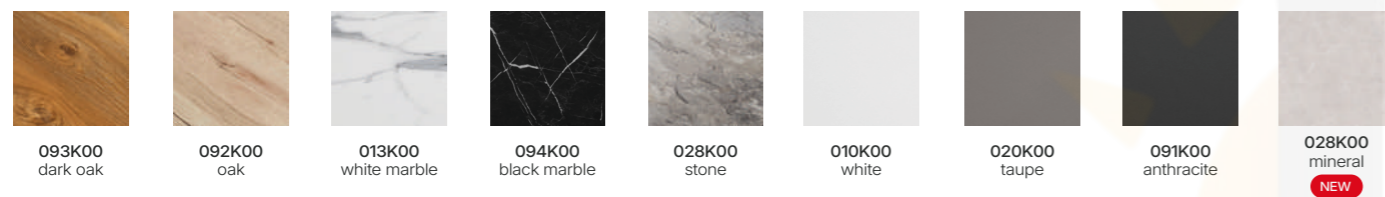

metal

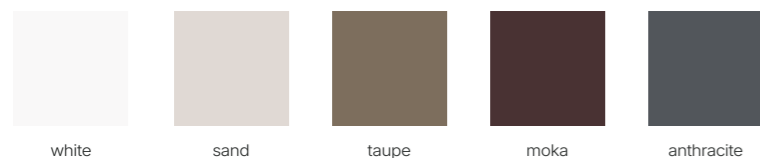

cura loop NEW FABRIC

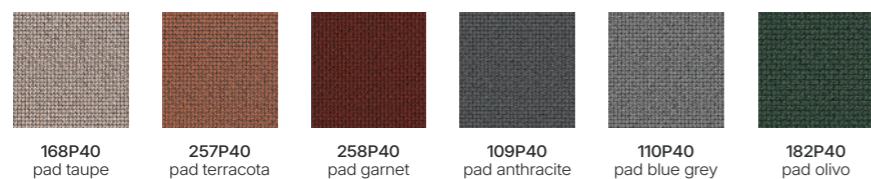

Gabriel Tejido de poliéster 100% reciclado. Pág 191
Tecido de poliéster 100% reciclado. Pág 191
Fabric made of 100% recycled polyester. Pag 191
Tissu en polyester 100% recyclé. Pag 191



olefin

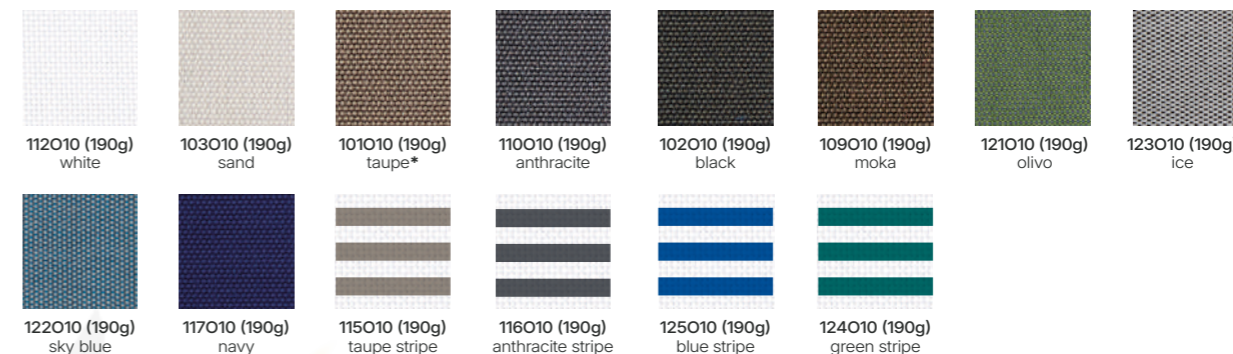

sunbrella



polyester 100% - Logo



phifertex®

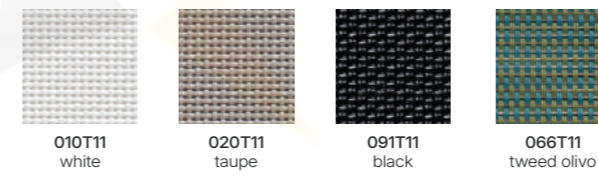

aqua

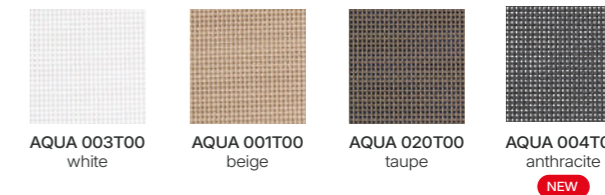

wood (bake)

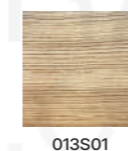

pad

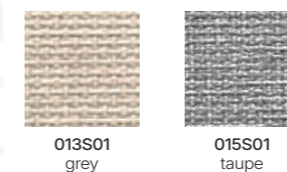

nautic

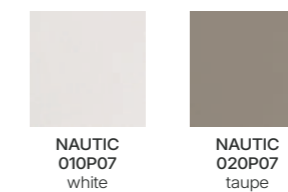

ibiza



new nautic (ibiza & nana)

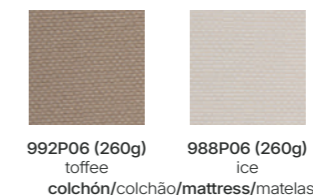

* Solidez 7-no recomendado para zonas de alta radiación solar. Solidez 7. Não recomendado para áreas de alta radiação solar.
Color fastness rating 7. Not recommended for areas with excessive sunlight exposure. Sa solidité est de 7. Déconseillé pour des zones à fort rayonnement solaire.