

COMPRAR  
TOLDOS.COM

PARASOL

CATÁLOGO 2024

# EOLO PURETI



white/white

taupe/sand

taupe/taupe

anthracite/ anthracite

## Tamaños / Tamanhos / Sizes / Tailles

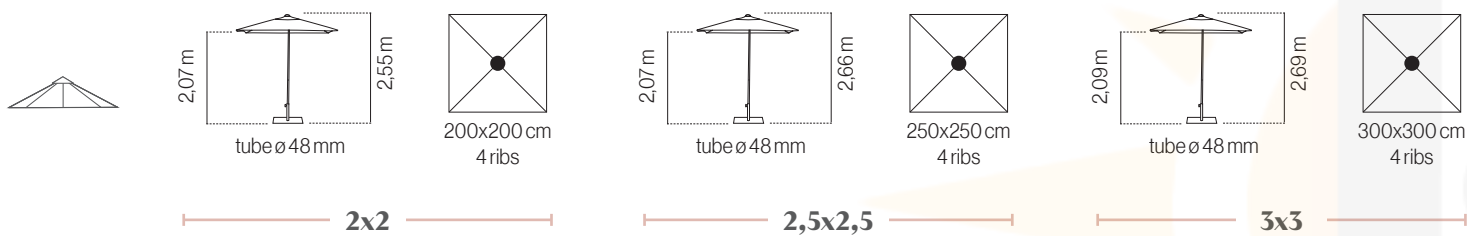

## Tejidos / Tecidos / Fabrics / Tissus

### Olefin



## Bases / Pieds (Pag. 186-187)

- CUBE •FIX •FASTCLICK •ROUND •MOULD •BOND •FLAT •CANTO

## Referencias / Referências / References / Références

Color frame	2x2	2,5x2,5	3x3
white	SPA010C2002721P	SIA010C2501720P	SGA010C3002720P
taupe	SPA010C2002821P	SIA010C2501820P	SGA010C3002820P
anthracite	SPA010C2002621P	SIA010C2501620P	SGA010C3002620P



Parasol de aluminio lacado con 4 varillas (20x14mm.). Apertura tipo push-up con sistema abre/cierra y pulsador de bloqueo. Sin volante y con fugavientos.

Guarda-sol em alumínio lacado com 4 varetas (20x14mm.). Abertura tipo push-up com sistema abre/fecha e botão de bloqueio. Sem bambinela e com fugaventos.

Lacquered aluminum parasol with 4 ribs (20x14mm.). Easy push-up open system with an open-lock handle. Without valance and with airvent.

Parasol aluminium laqué avec 4 baleines (20x14mm.). Ouverture push-up avec système d'ouverture / fermeture et verrouillage. Sans volant et avec soufflet.

Registered design No. 007003710 - Utility model No. 201931894



**EL PARASOL QUE PURIFICA EL AIRE - O GUARDA-SOL QUE PURIFICA O AR**  
**THE PARASOL THAT PURIFIES THE AIR - LE PARASOL QUI PURIFIE L'AIR**

pureti



Al igual que los árboles, el tejido de este parasol descontamina el aire de las ciudades, neutraliza los gases de los motores y otras sustancias nocivas. Incorpora una nanotecnología que, en contacto con la luz solar, convierte las sustancias contaminantes del aire en sales inertes.

Tal como as árvores, o tecido deste guarda-sol descontamina o ar das cidades, neutraliza os gases dos motores e outras substâncias nocivas. Tem incorporada uma nanotecnologia que, em contacto com a luz solar, converte as substâncias contaminantes do ar em sais inertes.

Much like trees, the fabric of this umbrella reduces city pollution, neutralizing engine gases and other harmful substances. Its nanotechnology, upon contact with sunlight, turns air pollutants into inert salts.

Tout comme les arbres, le tissu de ce parasol décontamine l'air des villes et neutralise les gaz d'échappement des moteurs et d'autres substances nocives. Il intègre une nanotechnologie qui, en contact avec la lumière du soleil, transforme les substances contaminantes de l'air en sels inertes.

# EOLO



white



taupe



anthracite

## Tamaños / Tamanhos / Sizes / Tailles

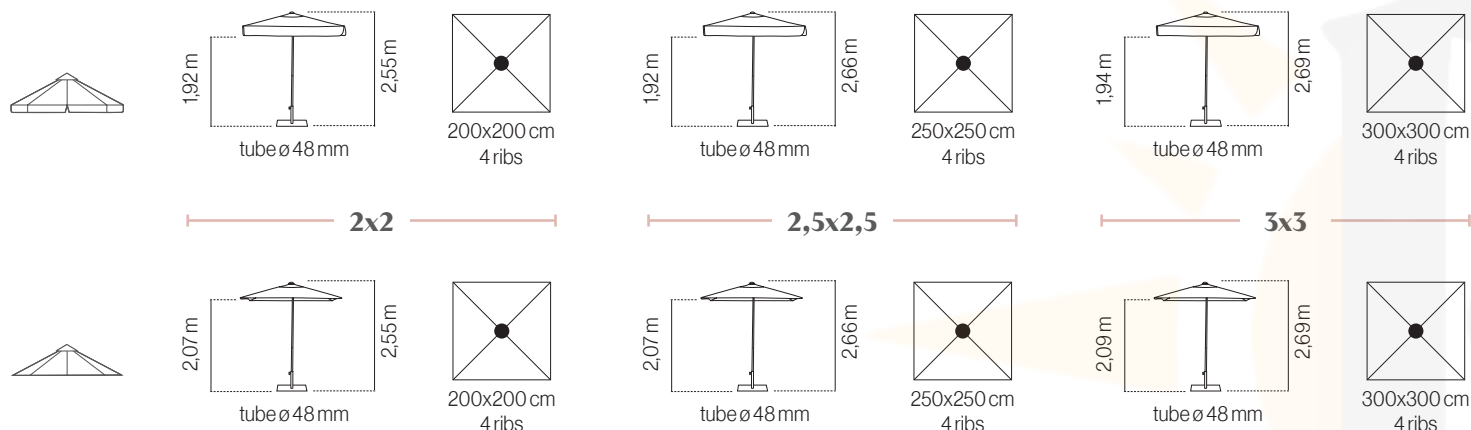

## Tejidos / Tecidos / Fabrics / Tissus

### Olefin



### Sumbrella

NEW



## Bases / Pieds (Pag. 186-187)

•CUBE •FIX •FASTCLICK •ROUND •MOULD •BOND •FLAT •CANTO



Parasol de aluminio lacado con 4 varillas (20x14mm). Apertura tipo push-up con sistema abre/cierra y pulsador de bloqueo. Sin volante y con fugavientos.

Guarda-sol em alumínio lacado com 4 varetas (20x14mm). Abertura tipo push-up com sistema abre/fecha e botão de bloqueio. Sem bambinela e com fugavientos.

Lacquered aluminum parasol with 4 ribs (20x14mm.). Easy push-up open system with an open-lock handle. Without valance and with airvent.

Parasol aluminium laqué avec 4 baleines (20x14mm.). Ouverture push-up avec système d'ouverture / fermeture et verrouillage. Sans volant et avec soufflet.

Registered design No. 007003710 - Utility model No. 201931894



## Referencias / Referências / References / Références

	Color frame	2x2	2,5x2,5	3x3
olefin	white	SPA010C2002740P	SIA010C2502740P	SGA010C3002740P
	taupe	SPA010C2002840P	SIA010C2502840P	SGA010C3002840P
	anthracite	SPA010C2002640P	SIA010C2502640P	SGA010C3002640P
olefin	white	SPA010C2002720P	SIA010C2502721P	SGA010C3002721P
	taupe	SPA010C2002820P	SIA010C2502821P	SGA010C3002821P
	anthracite	SPA010C2002620P	SIA010C2502621P	SGA010C3002621P
sumbrella	white	SPAD24C2002770P	SIAD24C2502771P	SGAD24C3002771P
	taupe	SPAD24C2002870P	SIAD24C2502871P	SGAD24C3002871P
	anthracite	SPAD24C2002670P	SIAD24C2502671P	SGAD24C3002671P

\* Los parasoles white/white, taupe/taupe, taupe/sand y antracita/antracita son Pureti - Os guarda sois branco/branco, taupe/taupe, taupe/sande Antracita/Antracita são - Parasols white/white, taupe/taupe, taupe/sand and anthracite/anthracite are Pureti - Les parasols blanc/blanc, taupe/taupe, taupe/sand et Antracite/Antracite sont Pureti



# FLEXO 3x3



white



taupe



anthracite

NEW

## Tamaños / Tamanhos / Sizes / Tailles

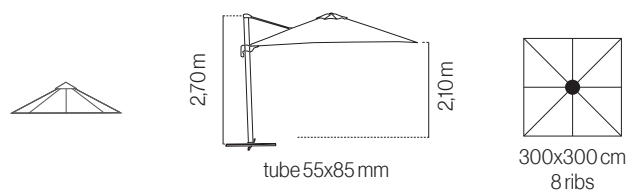

## Tejidos / Tecidos / Fabrics / Tissus

### Olefin

112010 white	103010 sand	101010 taupe	110010 anthracite	102010 black	109010 moka	121010 olivo
123010 ice	122010 sky blue	117010 navy	115010 taupe stripe	116010 anthracite stripe	125010 blue stripe	124010 green stripe

## Bases / Pieds (Pag. 186-187)

•SLAB •KITFLEXO

## Referencias / Referências / References / Références

Color frame	3x3
white	SGA010C3005021P
taupe	SGA010C3005022P
anthracite	SGA010C3005020P



Parasol de aluminio 3x3 m de mastil lateral con inclinación. 8 varillas (17x25 mm). Giratorio 360°. Sistema estabilizador. Sin volante y con fugavientos.

Guarda-sol em alumínio 3x3 m. de haste lateral com inclinação. 8 varetas (17x25 mm). Giratório 360°. Sistema estabilizador. Sem bambelina e com fugavientos.

3x3 m. aluminium lateral pole parasol with tilt system. 8 ribs (17x25 mm). 360° rotatory system. Stabilizer system. Without valance and with airvent.

Parasol mât 3x3 m. latéral avec inclinaison. 8 baleines (17x25 mm). Rotatif 360°. Système stabilisateur. Sans volant et avec soufflet.

(Cruceta incluida / cruzeta incluída / cross included / croix incluse)

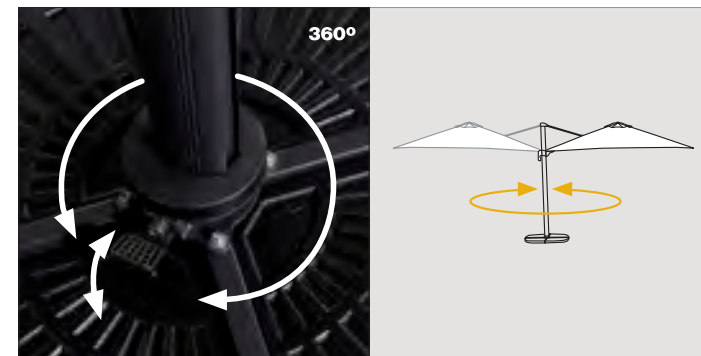
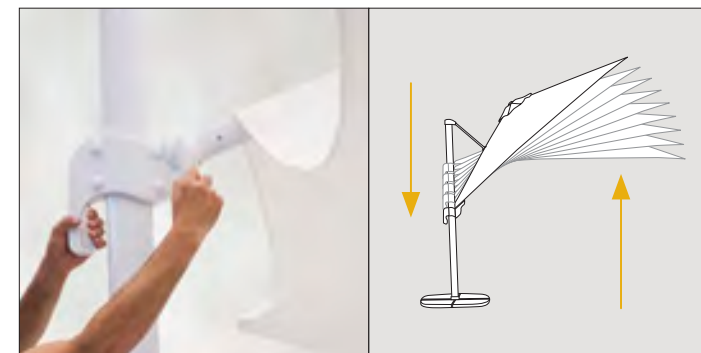

## RIO 4x4



white



anthracite

### Tamaños / Tamanhos / Sizes / Tailles

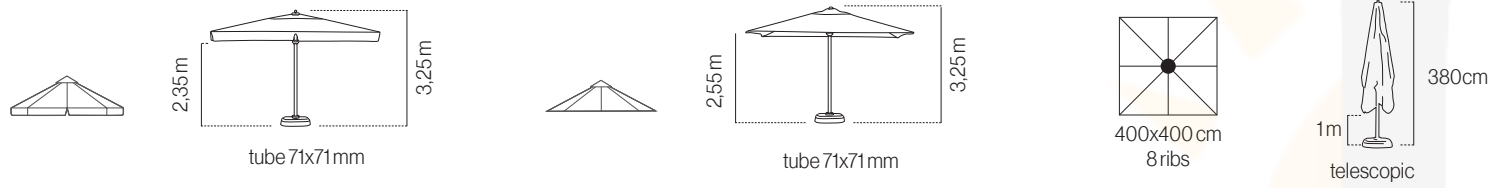

### Tejidos / Tecidos / Fabrics / Tissus



#### Olefin 250g

#### Waterproof

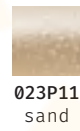

### Bases / Pieds (Pag. 186-187)

•KIT CROSSRIO •FIXRIO •FAST CLICKRIO

### Referencias / Referências / References / Références

	Color frame	4x4 olefin
olefin	white	SGA020C4000240P
	anthracite	SGA020C4000440P
olefin	white	SGA020C4000220P
	anthracite	SGA020C4000420P
waterproof	white	SGAP11C4000340P
	anthracite	SGAP11C4000440P



Parasol de aluminio lacado para terrazas grandes 4x4 m. 8 varillas intercambiables (20x35x1,5 mm). Apertura asistida manivela. Telescópico. Con o sin volante y con fugavientos.

Guarda-sol em alumínio lacado para esplanadas grandes 4x4 m. 8 varetas intercambiáveis (20x35x1,5 mm). Abertura assistida manivela. Telescópico. Com ou sem bambinela e com fugaventos.

Lacquered 4x4 m. aluminium parasol for big terraces. 8 exchangeable ribs (20x35x1,5 mm). Crank-assisted opening system. Telescopic. With or without valance and with airvent.

Parasol aluminium laqué pour grande terrasse 4x4 m. 8 baleines interchangeables (20x35x1,5 mm). Ouverture assistée manivelle. Téléscopique. Avec ou sans volant et avec soufflet.



Nuevo tejido impermeable. 67% poliéster - 33% PVC. Compatible con todos los parasoles Rio con faldón.

Novo tecido impermeável. 67% poliéster - 33% PVC. Compatível com todos os guarda-sois Rio com bambinela.

New waterproof fabric. 67% polyester - 33% PVC. Compatible with all Rio parasols with valance.

Nouveau tissu imperméable. 67% polyester - 33% PVC. Compatible avec le parasol Rio avec volants.

EN343

Level 3. Highest level of rain protection.





# FORMENTERA



white



anthracite

## Tamaños / Tamanhos / Sizes / Tailles

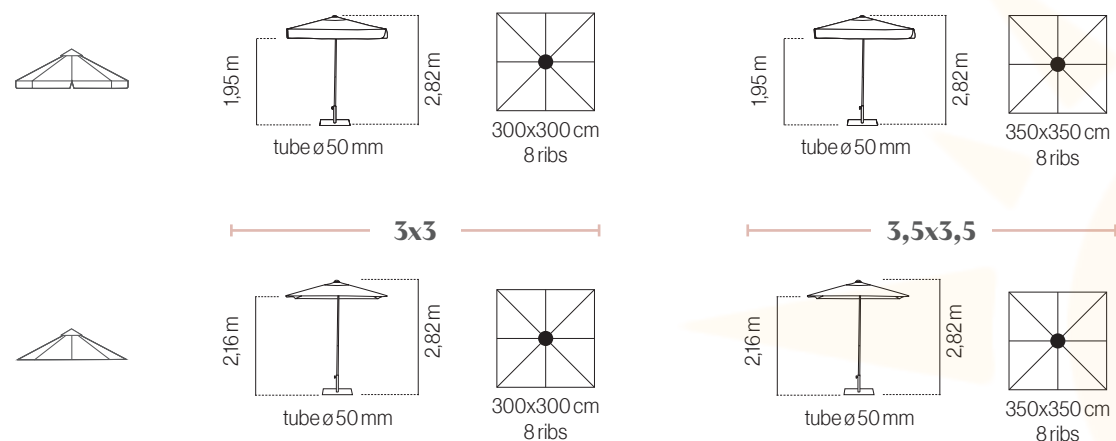

## Tejidos / Tecidos / Fabrics / Tissus

**Olefin**

- 112010 white
- 103010 sand
- 101010 taupe
- 110010 anthracite
- 102010 black
- 109010 moka
- 121010 olivo
- 123010 ice
- 122010 sky blue
- 117010 navy
- 115010 taupe stripe
- 116010 anthracite stripe
- 125010 blue stripe
- 124010 green stripe

**Waterproof**

- 023P11 sand

## Bases / Pieds (Pag. 186-187)

- KIT CROSS (3,5x3,5) •CUBE •FIX •FAST CLICK •BOND (3x3) •FLAT •CANTO

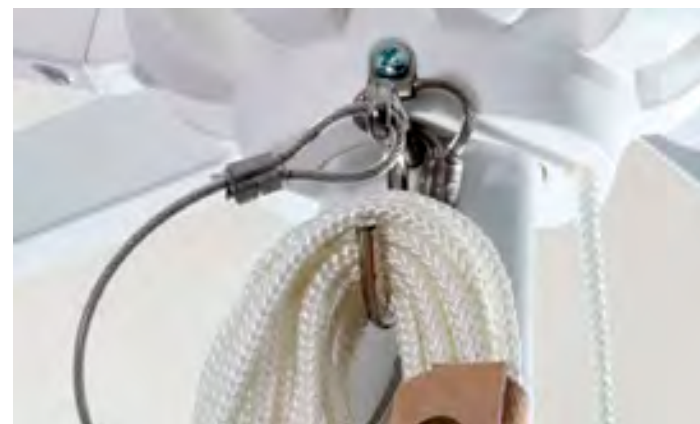

Parasol de aluminio lacado. 8 varillas (30x20 mm). Apertura por poleas. Sin volante y con fugavientos.  
 Guarda-sol em alumínio lacado. 8 varetas (30x20 mm). Abertura por roldanas. Sem bambinela e com fugaventos.  
 Lacquered aluminium parasol. 8 ribs (30x20 mm). Pulley opening system. Without valance and with airvent.  
 Parasol aluminium laqué. 8 baleines (30x20 mm). Ouverture par poulie. Sans volant et avec soufflet.



Nuevo tejido impermeable. 67% poliéster - 33% PVC. Compatible con todos los parasoles Formentera con faldón.  
 Novo tecido impermeável. 67% poliéster - 33% PVC. Compatível com todos os guarda-sois Formentera com bambinela.  
 New waterproof fabric. 67% polyester - 33% PVC. Compatible with all Formentera parasols with valance.  
 Nouveau tissu imperméable. 67% polyester - 33% PVC. Compatible avec tous les parasols Formentera avec volants.



EN343  
 Level 3. Highest level of rain protection.



## Referencias / Referências / References / Références

	Color frame	3x3	3,5x3,5
olefin	white	SGA010C3000240P	SGA010C3500140P
	anthracite	SGA010C3000540P	SGA010C3500340P
olefin	white	SGA010C3000220P	SGA010C3500120P
	anthracite	SGA010C3000520P	SGA010C3500320P
waterproof	white	SGAP11C3000242P	SGAP11C3500142P
	anthracite	SGAP11C3000542P	SGAP11C3500342P



grey

Tamaños / Tamanhos / Sizes / Tailles

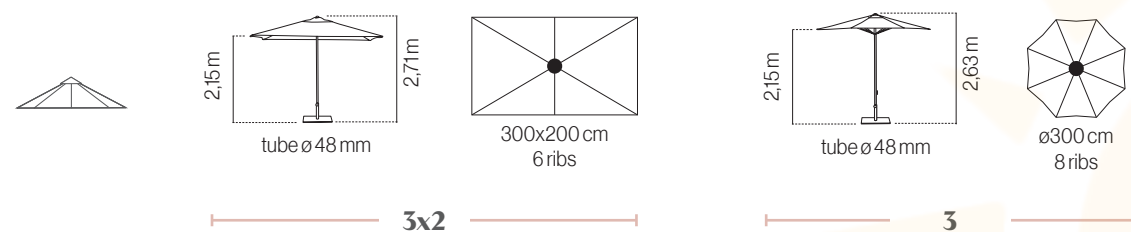

Tejidos / Tecidos / Fabrics / Tissus

Olefin



Bases / Pieds (Pag. 186-187)

- CUBE •FIX •FASTCLICK •ROUND •MOULD •BOND •FLAT •CANTO

Referencias / Referências / References / Références

	Color frame	3x2	3
	■ grey	SGA010H3000020P	SIA01003000820P



Parasol de aluminio lacado gris. 8 varillas (19x13 mm). Apertura por poleas. Sin volante y con fugavientos.  
 Guarda-sol em alumínio lacado cinza. 8 varetas (19x13 mm). Abertura por roldanas. Sem bambinela e com fugavientos.  
 Grey lacquered aluminium parasol. 8 ribs (19x13 mm). Pulley opening system. Without valance and with airvent.  
 Parasol aluminium laqué gris. 8 baleines (19x13 mm). Ouverture par poulie. Sans volant et avec soufflet.







Tamaños / Tamanhos / Sizes / Tailles

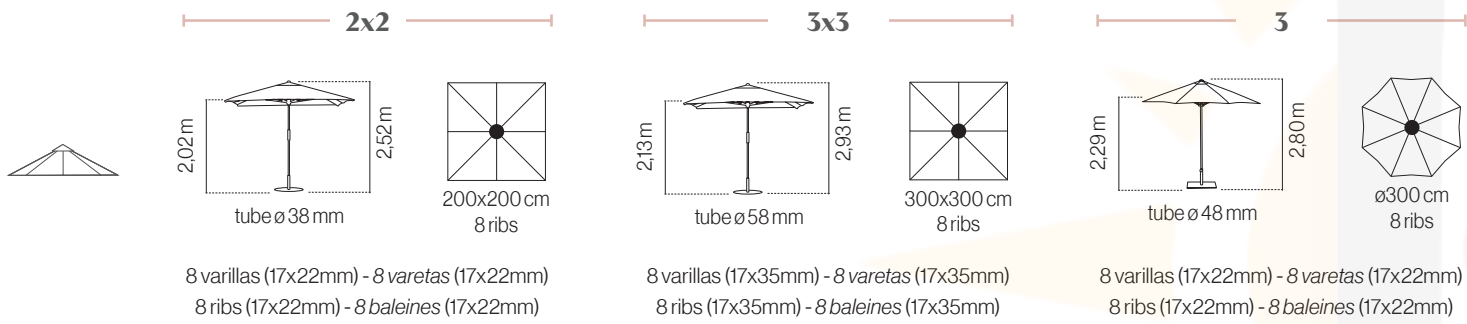

Tejidos / Tecidos / Fabrics / Tissus

Olefin



Bases / Pieds (Pag. 186-187)

•CUBE •FIX •FASTCLICK •ROUND •BOND •FLAT•CANTO

Referencias / Referências / References / Références

Color frame	2x2	3x3	3
wood	SPM010C2000220P	SGM010C3000220P	SIM01003000720P



Parasol de madera de eucalipto barnizada. 8 varillas. Apertura por poleas. Sin volante y con fugavientos. Madera procedentes de fuentes sostenibles. Certificado FSC.

Guarda-sol de madeira de eucalipto envernizada. 8 varetas. Abertura por roldanas. Sem bambinela e com fugaventos. Madeira proveniente de fontes reflorestadas. Certificado FSC.

Varnished eucalyptus wood parasol. 8 ribs. Pulley opening system. Without valance and with airvent. Wood from reforested sources. FSC certified.

Parasol bois d'eucalyptus verni. 8 baleines. Ouverture par poulie. Sans volant et avec soufflet. Bois provenant de sources reboisées. Certified FSC.





## MADEIRA 3

NEW

SIMO1003000750P

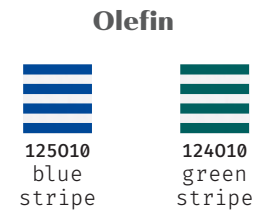
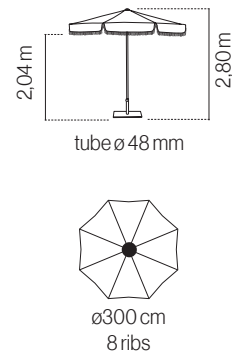

Parasol de madera de eucalipto barnizada. 8 varillas (17x22mm). Apertura por poleas. Con volante, fleco y fugavientos. Madera procedente de fuentes sostenibles.

Guarda-sol de madeira de eucalipto envernizada. 8 varetas (17x22mm). Abertura por roldanas. Com bambinela, franjas e fugavientos. Madeira proveniente de fontes reflorestadas. Certificado FSC.

Varnished eucalyptus wood parasol. 8 ribs (17x22mm). Pulley opening system. With valance, fringes and airvent. Wood from reforested sources. FSC certified.

Parasol bois d'eucalyptus verni. 8 baleines (17x22mm). Ouverture par poulie. Avec volants, franges et soufflet. Bois provenant de sources robisées. Certified FSC.



### Bases / Pieds (Pag. 186-187)

- CUBE
- FIX
- FAST CLICK
- ROUND
- BOND
- FLAT
- CANTO

## FARO INOX 2x2

SPIO10C2000320P

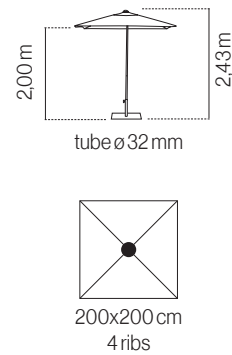

Parasol de INOX. 4 varillas de fibra de vidrio (12,5 mm). Apertura Push-Up. Sin volante y con fugavientos.

Guarda-sol em INOX. 4 varetas de fibra de vidro (12,5 mm). Abertura Push-Up. Sem bambinela e com fugavientos.

INOX parasol. 4 fiberglass ribs (12,5 mm). Push-Up opening system. Without valance and with airvent.

Parasol INOX. 4 baleines en fibre de verre (12,5 mm). Ouverture Push-Up. Sans volant et avec soufflet.



### Bases / Pieds (Pag. 186-187)

- ROUND
- FLAT
- FIT

## PALMA GREY 2,5

SIAO1002500000P

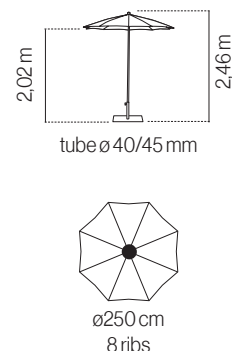

Parasol de aluminio. 8 varillas de fibra de vidrio (8 mm). Regulable en altura. Sin volante y sin fugavientos. Capito T extrarresistente.

Guarda-sol em aluminio. 8 varetas de fibra de vidro (8 mm). Regulável em altura. Sem bambinela e sem fugavientos. Tip T extraforte.

Aluminium parasol. 8 fiberglass ribs (8 mm). Adjustable height. Without valance and without airvent. Extrarresistant T tip.

Parasol aluminium. 8 baleines en fibre de verre (8 mm). Ajustable en hauteur. Sans volant et sans soufflet. Tip T extra forte.



### Bases / Pieds (Pag. 186-187)

- ROUND
- MOULD
- FLAT

## MENORCA 2,5

NEW

SIAO1002500006P

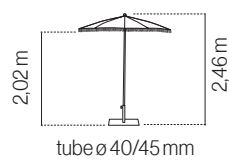

### Olefin



121010  
olivo



123010  
ice



122010  
sky blue



Parasol de aluminio. 8 varillas de fibra de vidrio (8 mm). Regulable en altura. Sin volante y sin fugavientos. Con flecos. Capito T extrarresistente.

Guarda-sol em alumínio. 8 varetas de fibra de vidro (8 mm). Regulável em altura. Sem bambinela e sem fugavientos. Com franjas. Tip T extraforte.

Aluminium parasol. 8 fiberglass ribs (8 mm). Adjustable height. Without valance and without airvent. Whit fringes. Extrarresistant T tip.

Parasol aluminium. 8 baleines en fibre de verre (8 mm). Ajustable en hauteur. Sans volant et sans soufflet. Avec franges. Tip T extra forte.



### Bases / Pieds (Pag.186-187)

- ROUND
- MOULD
- FLAT

## TENERIFE INOX 2

SPIO10D2005310P

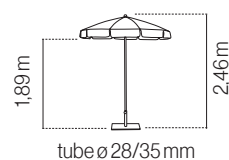

### Olefin



112010  
white



103010  
sand



101010  
taupe



110010  
anthracite



102010  
black



109010  
moka



121010  
olivo

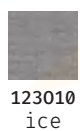

123010  
ice

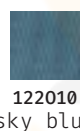

122010  
sky blue

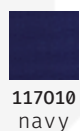

117010  
navy



115010  
taupe stripe

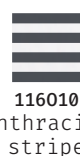

116010  
anthracite stripe



125010  
blue stripe



124010  
green stripe



Parasol de INOX con inclinación. 10 varillas de fibra de vidrio (6 mm). Regulable en altura. Con volante y sin fugavientos. Capito T extrarresistente.

Guarda-sol em INOX com inclinação. 10 varetas de fibra de vidro (6 mm). Regulável em altura. Com bambinela e sem fugavientos. Tip T extraforte.

INOX parasol with tilt system. 10 fiberglass ribs (6 mm). Adjustable height. With valance and without airvent. Extrarresistant T tip.

Parasol INOX avec inclinaison. 10 baleines en fibre de verre (6 mm). Ajustable en hauteur. Avec volants et sans soufflet. Tip T extra forte.



INOX

### Bases / Pieds (Pag.186-187)

- ROUND
- MOULD
- FLAT
- FIT

## ONS SAND 2

SPA010D2000110T

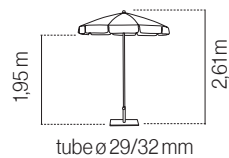

### Olefin



112010  
white



103010  
sand



101010  
taupe



110010  
anthracite



102010  
black

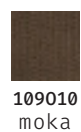

109010  
moka



121010  
olivo



123010  
ice

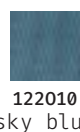

122010  
sky blue



117010  
navy



115010  
taupe stripe

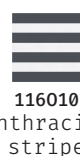

116010  
anthracite stripe



125010  
blue stripe



124010  
green stripe



Parasol de aluminio lacado sand. 10 varillas de fibra de vidrio (6 mm). Regulable en altura. Con volante y sin fugavientos. Capito T extrarresistente.

Guarda-sol em alumínio lacado sand. 10 varetas de fibra de vidro (6 mm). Regulável em altura. Com bambinela e sem fugavientos. Tip T extraforte.

Sand lacquered aluminium parasol. 10 fiberglass ribs (6 mm). Adjustable height. With valance and without airvent. Extrarresistant T tip.

Parasol aluminium laqué sand. 10 baleines en fibre de verre (6 mm). Ajustable en hauteur. Avec volants et sans soufflet. Tip T extra forte.



### Bases / Pieds (Pag.186-187)

- ROUND
- FLAT
- FIT



## NEW TOSCANA

NEW

SPA010D2000150T

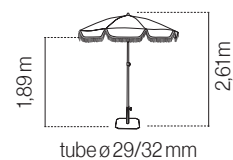

0011010  
olivo/sand



0012010  
sky blue



103010  
sand/sand

Olefin



Parasol de aluminio lacado sand. 10 varillas de fibra de vidrio (6 mm). Regulable en altura. Con flecos. Con volante y sin fugavientos. Capito T extrarresistente.

Guarda-sol em alumínio lacado sand. 10 varetas de fibra de vidro (6 mm). Regulável em altura. Com franjas. Com bambelina e sem fugavientos. Tip T extraforte.

Sand lacquered aluminium parasol. 10 fiberglass ribs (6 mm). Adjustable height. With fringes. With valance and without airvent. Extrarresistant T tip.

Parasol aluminium laqué sand. 10 baleines en fibre de verre (6 mm). Ajustable en hauteur. Avec franges et volants et sans soufflet. Tip T extra forte.



OLEFIN  
FIBER  
190g

**Bases / Pieds** (Pag.186-187)

- ROUND
- FLAT
- FIT

## MANILA NATURAL 2

SPSZ02D2000001T

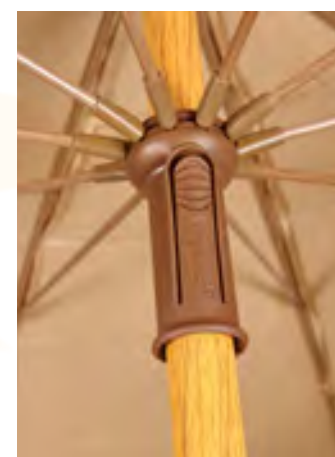
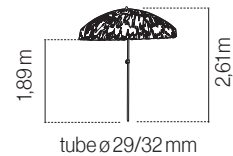

Parasol de acero imitación madera natural. 10 varillas de fibra de vidrio (6 mm). Regulable en altura. Con volante y sin fugavientos.

Guarda-sol em aço imitação madeira natural. 10 varetas de fibra de vidro (6 mm). Regulável em altura. Com bambelina e sem fugavientos.

Natural wood finishing steel parasol. 10 fiberglass ribs (6 mm). Adjustable height. With valance and without airvent.

Parasol acier finition bois naturel. 10 baleines en fibre de verre (6 mm). Ajustable en hauteur. Avec volants et sans soufflet.

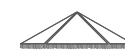

UPF50+

**Bases / Pieds** (Pag.186-187)

- ROUND
- FLAT
- FIT

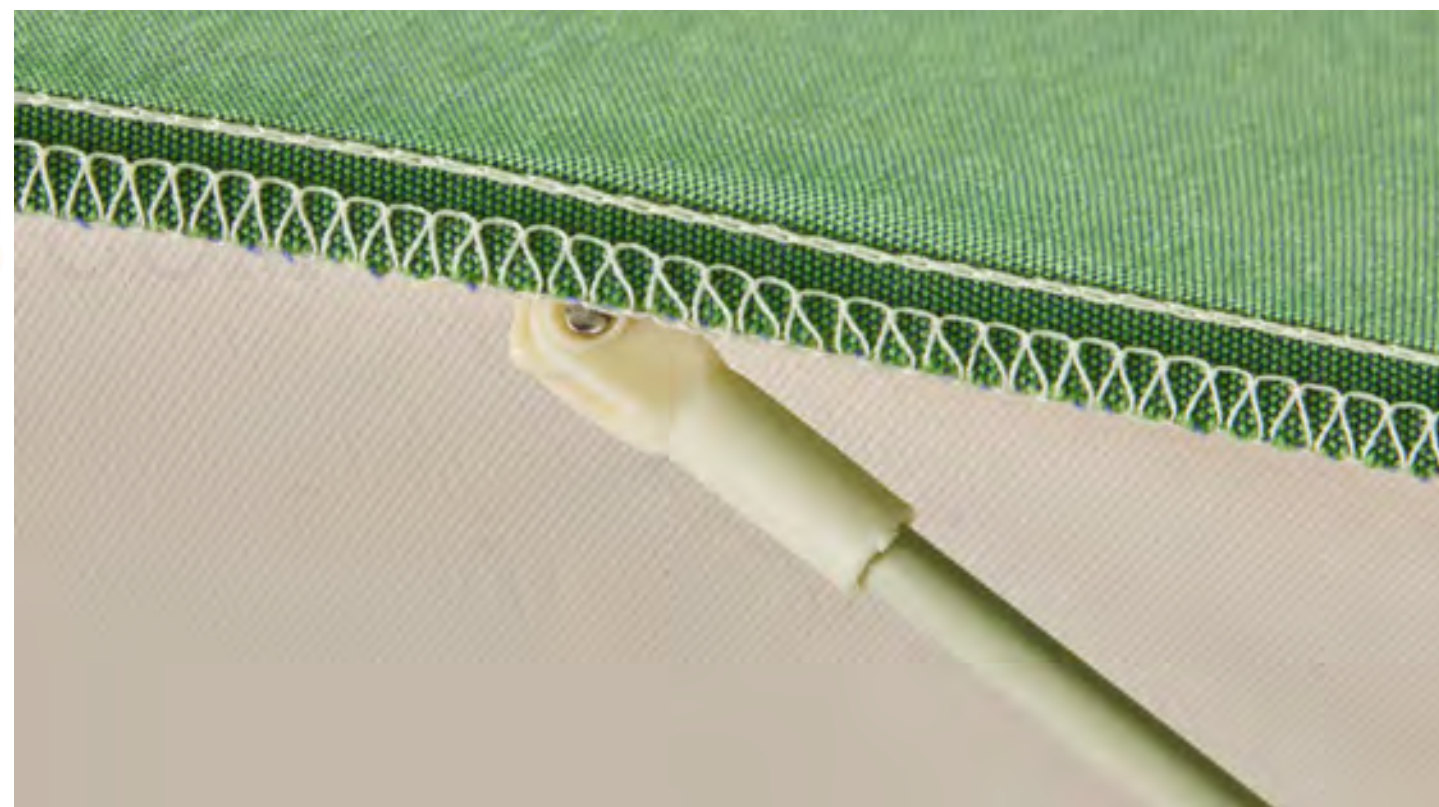



## FUNDA PARASOL - CAPA GUARDA-SOL - PARASOL COVER - COUVERTURE PARASOL



REF. 31P18C40000  
RIO 400X4000

REF. 31P18C35000  
FORMENTERA 350X350  
FLEXO 300X300

REF. 31P18C30000  
FORMENTERA 300X300  
VIGO 300X300 - JAVA 300X300

REF. 31P18C25000  
EOLO - VIGO - JAVA

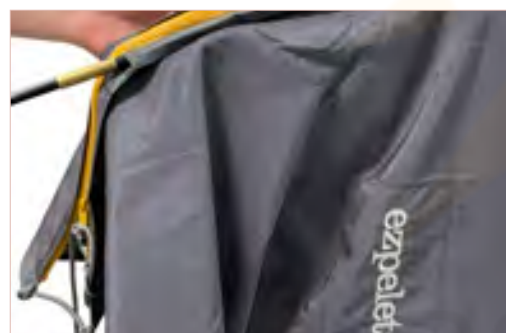

POLYESTER  
210g

WATER PROOF

+ INFO



## CANALON/CALEIRA/GUTTER/GOUTTIÈRES

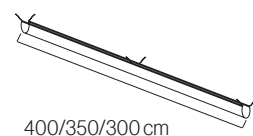

400/350/300cm

4x4 - IGAP00C40002  
3,5x3,5 - IGAP00C35002  
3x3 - IGAP00C30002





## SUNBRELLA

NEW

Tejido exclusivamente con fibras acrílicas teñidas en masa desde el núcleo del mismo hilo para garantizar su resistencia a la decoloración frente a los rayos UV. Acabado repelente al agua, resistente al moho y antimanchas que protege el tejido y hace que su mantenimiento sea muy sencillo.

Garantía de 5 años frente a la abrasión, la aparición de bolitas, la decoloración y la pérdida de tensión.

Cuenta con el Sello de Recomendación de la Skin Cancer Foundation (Fundación contra el Cáncer de la Piel) que garantiza la protección de la piel de los efectos nocivos de los rayos UV.

*Tecido exclusivamente com fibras acrílicas tingidas em massa a partir do núcleo do próprio fio para garantir a sua resistência à descoloração contra os raios UV. O acabamento repelente à água, ao mofo e às manchas protege o tecido e facilita a sua manutenção.*

*5 anos de garantia contra abrasão, borboto, descoloração e perda de tensão.*

*Com o Selo de Recomendação da "Skin Cancer Foundation" que garante a proteção da pele contra os efeitos nocivos dos raios UV.*

The fabric is exclusively crafted from acrylic fibers, dyed thoroughly within the core of the yarn to ensure resistance against UV-induced fading. Its water-repellent, mold-resistant, and stain-repellent finish safeguards the fabric, simplifying maintenance.

It is backed by a 5-year warranty against abrasion, pilling, fading, and tension loss.

Endorsed by the Skin Cancer Foundation Seal, guaranteeing protection against the harmful effects of UV rays on the skin.

*Tissu exclusivement en fibres acryliques teinté à la masse depuis son processus initial, afin de garantir une haute résistance à la décoloration due aux rayons UV. Toile déperlante, résistante aux moisissures, anti-tâches qui facilite ainsi son entretien.*

*Toile garantie 5 ans, contre l'abrasion, les bouloches, decolation et pertes de tension.*

*Certifiée est recommandée par la "SKIN CANCER FOUNDATION" qui garantit la protection de la peau aux effets nocifs des rayons UV.*

**sunbrella™**

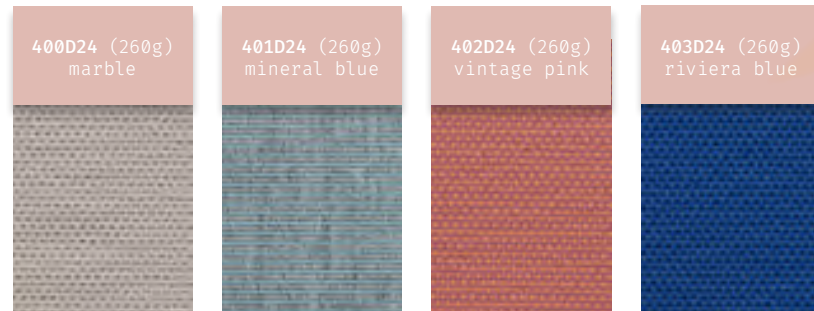

## DRALON

Tejido tintado en floca, solidez 5-6 sobre 8. En zonas de alta radiación y sobreexposición solar los colores oscuros pierden intensidad antes de los 6 meses, para estas zonas recomendamos colores claros como el blanco o el crudo.

*Tecido tingido em bando, solidez 5-6 de 8. Em áreas de alta radiação e sobre exposição ao sol, as cores escuras perdem intensidade antes dos 6 meses, para essas áreas recomendamos cores claras como branco ou crula piel de los efectos nocivos de los rayos UV.*

Fabric dyed in the fiber, color fastness rating 5-6 out of 8. In zones with excessive sunlight exposure, dark colors may lose intensity within less than 6 months. For such areas, we recommend light colors such as white or beige.

Tissu teint avec flochage, solidité 5-6 sur 8. Dans les zones de fort rayonnement et de surexposition solaire, les couleurs sombres perdent de leur intensité après 6 mois d'utilisation. Pour ces zones nous recommandons des couleurs claires, comme l'écreu ou le blanc.



## OLEFIN

Alta solidez de los colores a la radicación UV (7/8). Se trata de un tejido fabricado con hilo de polipropileno que ha sido tintado en masa, en su proceso inicial. Esto le otorga una gran resistencia a la luz solar ya que el color queda fijado en el hilo del tejido con mayor intensidad que en otros procesos. Dependiendo del color varía la durabilidad de la intensidad de los colores a la exposición solar.

Certificación UV standard 801 con la puntuación UPF 80, que garantiza la protección de la piel de los efectos nocivos de los rayos UV.

Repelente al agua - resistente a las manchas - 100% reciclable.

*Alta resistência das cores face à radiação UV. Ao ser um tecido fabricado com fio de polipropileno tingido em massa no seu processo inicial, esta característica confere-lhe uma maior resistência à luz solar o que se deve essencialmente ao facto de a cor permanecer fixa ao fio com maior intensidade do que em outros processos de pigmentação. A durabilidade da intensidade das cores, varia dependendo da cor e da exposição solar.*

*Certificação UV standard 801 com factor de proteção UPF 80, que garante a proteção da pele dos efeitos nocivos dos raios UV.*

*Repelente à água - anti-manchas - 100% reciclável.*

High resistance of colours to UV radiation (7/8). The fabric is made from polypropylene fabric mass-dyed during the initial process. This provides high resistance to sunlight because the colour is set in the thread of the fabric more intensely than in other processes. Depending on the color, the durability of color intensity varies when exposed to sunlight.

UV standard 801 certification rating UPF 80, that guarantees skin protection against nocive effects of UV rays on the skin.

Water repellent - stain resistance - 100% recyclable.

*Haute résistance des couleurs face à la radiation solaire. Il s'agit ici d'une toile fabriquée à partir d'un fil en polypropylène qui a été teinté en masse, depuis son processus initial. Ceci lui confère une haute résistance à la lumière solaire, étant donné que la teinte reste fixée sur le fil avec une plus grande intensité en comparaison avec d'autres processus de pigmentation. Selon la couleur choisie, la durabilité de l'intensité de celle-ci varie en fonction de l'exposition au soleil.*

*Certification UV standard 801 avec un facteur de protection UPF 80, qui garantie une protection de la peau face aux effets nocifs des rayons UV.*

*Deperlante - résistante toile aux tâches - 100% recyclable.*



SOLUTION DYED - COLOUR FASTNESS: 7-8/8 - 100% RECYCLABLE

Disponemos de un tejido de poliéster 100% tintado en masa para pedidos con logotipo.

*Temos um tecido 100% poliéster tingido em massa para pedidos com logotipo.*

We have a 100% mass-dyed polyester fabric for orders with a logo.

*Nous avons un tissu 100% polyester teint dans la masse pour les commandes avec logo.*

\* Solidez 7-no recomendado para zonas de alta radiación solar. Solidez 7-Não recomendado para áreas de alta exposição solar. Color fastness rating 7-not recommended for areas with excessive sunlight exposure. Sa solidité est de 7-Déconseillé pour des zones à fort rayonnement solaire.

**SLAB (cemento/polipropileno - cemento/polipropileno - concrete/polypropylene - iment/polypropylène)**

Flexo

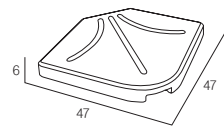

25kg  
100kg (4U/)



**BEC047BC03**  
white



**BEC047TP03** NEW  
taupe



**BEC047NG02**  
anthracite

**KIT FLEXO (hierro/cemento/polipropileno - ferro/cemento/polipropileno - iron/concrete/polypropylene fer/ciment/polypropylène)**

Flexo

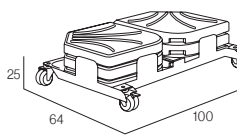

150kg + 15kg (base)



**BSH990BCK**  
white



**BSH990TPK**  
taupe



**BSH990ANK**  
anthracite

**KIT CROSS (hierro/cemento - ferro/cemento - iron/concrete - fer/ciment)**

Rio  
Formentera

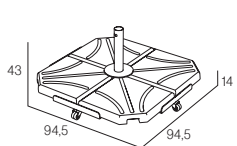

100kg + 10kg (base)



**BSRDBC6350K**  
CROSS RIO - white



**BSRDAN6350K**  
CROSS RIO - anthracite



**BSRDBC6000K**  
CROSS - white



**BSRDAN6000K**  
CROSS - anthracite

**CUBE (cemento - cemento - concrete - ciment)**

Eolo  
Formentera  
Vigo  
Java 2X2  
Java 3  
Madeira

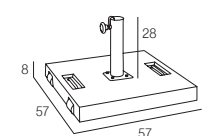

50kg  
poles ø38 - 50mm



**BEC570BC00**  
white



**BEC570GR00**  
grey

**FIX (hierro - ferro - iron - fer)**

Eolo  
Rio  
Formentera  
Vigo  
Java 3  
Madeira

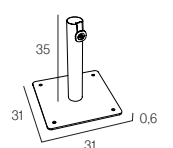

10kg  
poles ø48 - 50mm

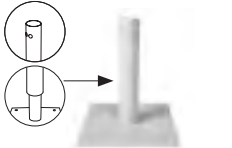

**BSC310BC63501**  
FIX RIO  
white



**BSC310AN63500**  
FIX RIO  
anthracite



**BSC310GR6000**  
FIX  
grey



**BSC310BC6000**  
FIX  
white



**BSC310TP6000**  
FIX  
taupe

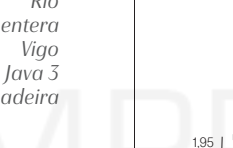

**BSC310AN6000**  
FIX  
anthracite

**FAST CLICK (inox)**

Eolo  
Rio  
Formentera  
Vigo  
Java 3  
Madeira



poles ø38 - 48 - 50mm

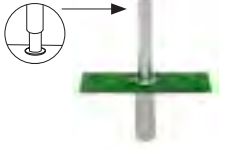

**BIFC63500**  
FAST CLICK RIO  
inox



**BIFC6000 - ø60**  
FAST CLICK  
inox



**BIFC5500 - ø55**  
FAST CLICK  
inox



+ INFO



**ROUND (cemento - cemento - concrete - ciment) \***

Eolo  
Vigo  
Java 2x2  
Java 3  
Madeira  
Faro  
Palma  
Menorca  
Tenerife  
Ons  
New toscana  
Manila

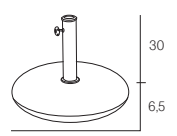

25kg  
poles ø32 - 48mm



**BER048TP01**  
taupe

**MOULD (cemento/polipropileno - cemento/polipropileno - concrete/polypropylene - ciment/polypropylène) \***

Eolo  
Vigo  
Palma  
Menorca  
Tenerife

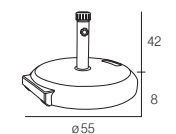

38kg  
poles ø35 - 48 mm



**BER055GR00**  
grey

**BOND (cemento/polipropileno - cemento/polipropileno - concrete/polypropylene - ciment/polypropylène)**

Eolo  
Formentera 3x3  
Vigo  
Java 3  
Madeira

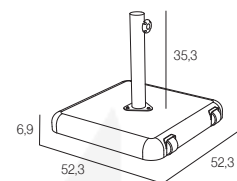

35kg  
poles ø48 - 50 mm



**BPC523GR6000**  
grey



**BPC523BC6000**  
white



**BPC523TP6000**  
taupe



**BPC523AN6000**  
anthracite

Base de cemento con carcasa de polipropileno, tubo de acero lacado con tratamiento antióxido (cataforesis), tornillería de acero zincado y ruedas.

Base de cemento com revestimento em polipropileno, tubo em aço lacado com tratamento anti-ferrugem (cataforesis), parafusos em aço zincado e com rodas.

Cement base with polypropylene casing, anti-rust treated (cataphoresis) coated steel tubing, castors and stainless steel screws.

Base en ciment revêtit de polypropylène, tube en acier laqué avec traitement anti-rouille (cataphorèse), vis et roues en acier zingué.



**FLAT (hierro - ferro - iron - fer)**

Eolo  
Vigo  
Java  
Madeira  
Faro  
Palma  
Menorca  
Tenerife  
Ons  
Toscana  
Manila

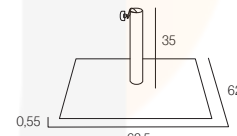

18kg  
poles ø32 - 38 - 40 - 48 mm



**BSC625GR40030** ø40  
**BSC625GR60000** ø60  
grey



**BSC625BC6000** ø60  
white



**BSC625TP6000** ø60  
taupe



**BSC625AN6000** ø60  
anthracite



**BSC625OX55000** ø40  
**BSC625OX45000** ø55  
rust

**CANTO (hierro - ferro - iron - fer)**

Eolo  
Formentera  
Vigo  
Java 3  
Java 3X3  
Madeira

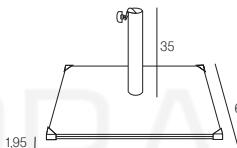

35kg  
poles ø48 - 50 / ø57 mm



**BSC625GR6010** ø60  
grey



**BSC625BC6010** ø60  
white



**BSC625TP6010** ø60  
taupe



**BSC625AN6010** ø60  
anthracite



**BSC625OX6010** ø60  
**BSC625OX7010** ø70  
rust

Cantonerías de acero inoxidable para separar la chapa del suelo.

Protectores de aço inoxidável para separar a chapa do chão.

Stainless steel corner pieces to separate sheet metal from the floor.

Extrémities en acier inoxydable pour séparer la tôle du sol.



**MO-SIE41K (kit 4 U/)**  
Rueda con freno - roda com travão - wheels with brake - roue avec frein.

**FIT (hierro - ferro - iron - fer)**

Faro  
Tenerife  
Ons  
Toscana  
Manila

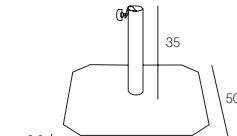

12kg  
poles ø40 - 45mm



**BS0500GR4003** ø40  
**BS0500GR4503** ø45  
grey



**BS0500BC4002** ø40  
white



**BS0500OX4000** ø40  
rust

\* ROUND, MOULD - hasta fin de existencias, Limitado ao stock existente. Up to end of stock, Jusqu' à fin de stocks.