

# MOSQUITERA ENROLLABLE

Ventanas y Puertas



**Mosquiflex**<sup>®</sup>



**COMPRAR  
TOLDOS.COM**

[www.compartoldos.com](http://www.compartoldos.com)  
[info@compartoldos.com](mailto:info@compartoldos.com)

## TARIFA 2018

Descuento 20% (en toda la tarifa)

IVA incluido

Transporte incluido\*

\*Para importe Fra. superior a 150,00€

Nota: El transporte será hasta pie de finca (acera)



## Enrollables Ventana



### CAJÓN 35

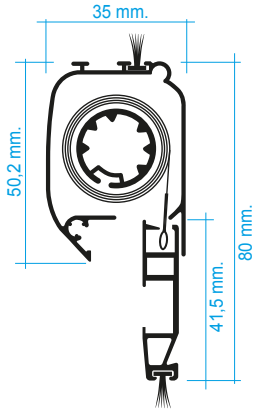

### CAJÓN 42

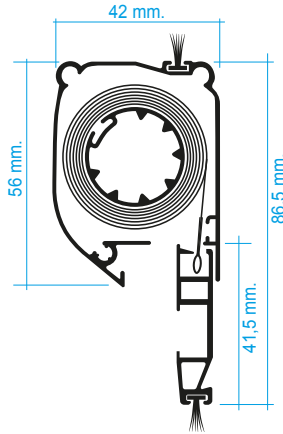

ANCHO

MÁXIMOS A FABRICAR



ALTO

ANCHO MÍNIMO A FABRICAR 0,41 EN LOS 2 MODELOS

## Colores Estándar

Grupo 1	Grupo 2	Grupo 3	Grupo 4
- Lacado Blanco 0002	- Anodizado Plata 0003	- Anodizado Bronce 0004	<b>IMITACIÓN MADERA</b>
	- Ral 1015 - Ral 7016	- Anodizado INOX 0005	- Nogal Oscuro 0007
	- Ral 3005 - Ral 7022	- Gris Grafito 0006	- Roble Claro 0008
	- Ral 6005 - Ral 8014		- Nogal Español 0009
	- Ral 6009 - Ral 8017		- Pino Nudo 0010
	- Ral 7011 - Ral 9011-Mate		- Embero "Texturado" 0011

¡DE LOS COLORES INDICADOS MANTENEMOS EXISTENCIAS PERMANENTES!  
Podemos suministrar mosquiteras en cualquier otro color de la carta RAL .

## Precios de lacados

1 Uds.	HASTA 6 Uds.	HASTA 15 Uds.	HASTA 25 Uds.	HASTA 35 Uds.	HASTA 50 Uds.	MÁS DE 50 Uds.
75,00	125,00	200,00	275,00	350,00	475,00	Se aplicarán los Precios del Grupo 2

El plazo de entrega será de 10 días

# Precios

## Enrollables Ventana. Colores grupo 1

Alto \ Ancho		0,60	0,80	1,00	1,20	1,40	1,60	1,80	2,00	2,20
1,00	35	55	60	64	68	72	77			
	42	57	62	66	71	75	80	85	89	94
1,20	35	57	62	66	70	75	79			
	42	59	64	68	73	78	82	87	91	96
1,40	35	60	65	69	74	78	83			
	42	62	67	72	76	81	86	91	95	100
1,60	35	62	67	71	76	80	85			
	42	64	69	74	79	83	88	93	98	102
1,80	1,75 35	65	69	74	78	83	87			
	42	67	73	78	83	88	93	98	103	108
2,00	42	70	75	80	85	90	95	100	106	111
2,20	42	72	77	82	87	92	98	103	108	113
2,40 2,35	42	74	79	84	90	95	100	105	110	115

A efectos de precio se redondeará a la inmediata superior.

## Enrollables Ventana. Colores grupo 2

Alto \ Ancho		0,60	0,80	1,00	1,20	1,40	1,60	1,80	2,00	2,20
1,00	35	57	62	66	71	76	80			
	42	59	64	69	74	79	84	89	93	98
1,20	35	60	64	69	74	78	83			
	42	62	67	71	76	81	86	91	96	101
1,40	35	63	68	72	77	82	87			
	42	65	70	75	80	85	90	95	100	105
1,60	35	65	70	75	80	84	89			
	42	67	72	77	82	88	93	98	103	108
1,80	1,75 35	68	73	77	82	87	92			
	42	71	76	82	87	92	98	103	109	114
2,00	42	73	79	84	90	95	100	106	111	117
2,20	42	76	81	87	92	97	103	108	114	119
2,40 2,35	42	78	84	89	95	100	105	111	116	122

A efectos de precio se redondeará a la inmediata superior.

## Enrollables Ventana. Colores grupo 3

Alto \ Ancho		0,60	0,80	1,00	1,20	1,40	1,60	1,80	2,00	2,20
1,00	35	61	66	71	76	81	86			
	42	63	68	74	79	85	90	95	101	106
1,20	35	64	69	74	79	84	89			
	42	66	71	77	82	87	93	98	104	109
1,40	35	68	73	78	83	88	93			
	42	70	75	81	86	92	97	103	108	114
1,60	35	71	76	81	86	91	96			
	42	73	78	84	89	95	100	106	111	117
1,80	1,75 35	74	79	84	89	94	99			
	42	77	83	88	94	100	106	112	118	124
2,00	42	80	85	91	97	103	109	115	121	127
2,20	42	83	88	94	100	106	112	118	124	130
2,40 2,35	42	86	91	97	103	109	115	121	127	133

A efectos de precio se redondeará a la inmediata superior.







# Precios

## Enrollables Ventana. Colores grupo 4

Alto	Ancho	0,60	0,80	1,00	1,20	1,40	1,60	1,80	2,00	2,20
1,00	35	75	82	88	95	101	108			
	42	77	85	92	99	106	113	120	127	135
1,20	35	80	86	93	99	106	113			
	42	82	89	97	104	111	118	125	132	139
1,40	35	85	92	99	105	112	119			
	42	88	95	102	110	117	124	132	139	146
1,60	35	90	97	103	110	117	124			
	42	92	100	107	114	122	129	136	144	151
1,80	1,75 35	95	101	108	115	122	128			
	42	98	106	114	121	129	137	144	152	160
2,00	42	103	111	118	126	134	141	149	157	164
2,20	42	108	115	123	131	138	146	154	161	169
2,40 2,35	42	113	120	128	136	143	151	159	166	174

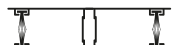
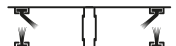
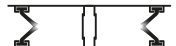
A efectos de precio se redondeará a la inmediata superior.

## Incrementos

CROQUIS	DESCRIPCIÓN	€/Ud. MOSQUITERA
A  B  C 	Guías con Felpudo Estándar	<b>Sin Incremento</b>
	Guías con 1 Felpudo Antiviento	<b>1,90</b>
	Guías con 2 Felpudos Antiviento	<b>3,80</b>
A  B  C 	Guía doble con Felpudo Estándar	<b>Sin Incremento</b>
	Guía doble con 1 Felpudo Antiviento	<b>1,90</b>
	Guía doble con 2 Felpudos Antiviento	<b>3,80</b>
	Kit instalación frontal Común para los 2 cajones	<b>Sin Incremento</b>
	Muelle retención - 42	<b>6,00</b>
	Clip instalación cajón 35	<b>3,00</b>
	Clip instalación cajón 42	<b>3,00</b>

# Componentes

		Clip Instalación <b>OPCIONAL</b>		TETUG (Malla enrollada en su eje)					DENOMINACIÓN		
Cajón completo	Instalación Frontal	35	42	20		25					
				1400	1700	1400	1700	2300			
Cajón completo	Instalación Frontal	35	42							<p>① Kit</p> <p>② Kit</p>	
				20-1700							
				20-1400							
				25-2300							
				25-1700							
				25-1400							
				A	B	C	A	B	C		
				Guía con Felpudo			Guía doble con Felpudo				



# Enrollable Puerta

MEDIDAS A FABRICAR	ENROLLABLE PUERTA	← ANCHO →		↕ ALTO ↕	
		MÍNIMO	MÁXIMO	MÍNIMO	MÁXIMO
	PUERTA ÚNICA	-	1,40	1,40	2,50
PUERTA DOBLE	-	2,80			

El ALTO debe ser siempre al menos 15 cm. más que el ANCHO de cada puerta.

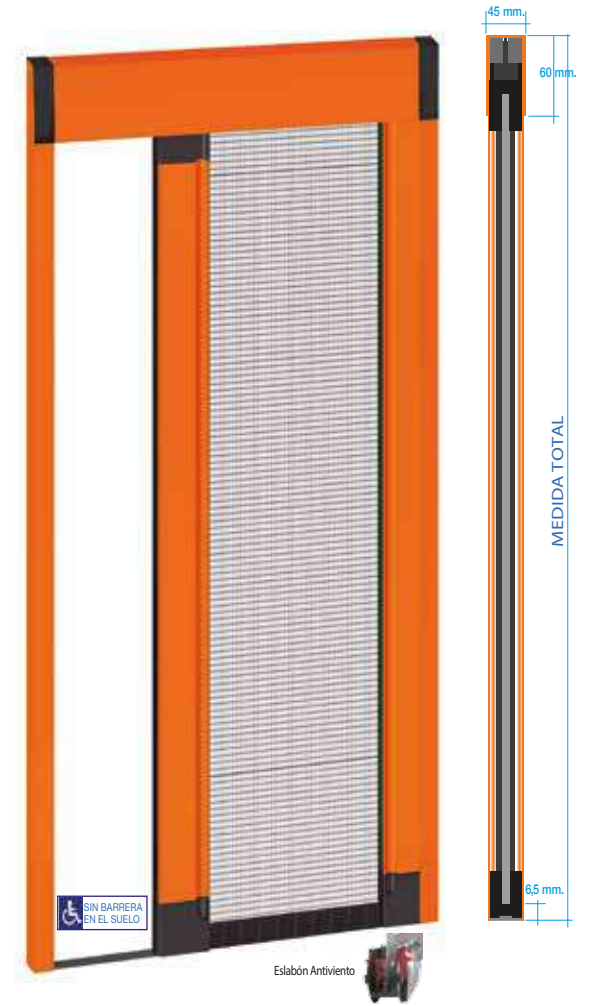

## Colores Estándar

Grupo 1	Grupo 2*	Grupo 3	Grupo 4
- Lacado Blanco 0002	- Ral 1015 - Ral 7016 - Ral 3005 - Ral 7022 - Ral 6005 - Ral 8014 - Ral 6009 - Ral 8017 - Ral 7011 - Ral 9011-Mate * Plazo de entrega 10 días.	No disponible	No disponible

¡DE LOS COLORES INDICADOS MANTENEMOS EXISTENCIAS PERMANENTES!  
Podemos suministrar mosquiteras en cualquier otro color de la carta RAL

PERFIL SUPERIOR

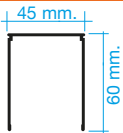

PERFIL INFERIOR



PUERTA ÚNICA

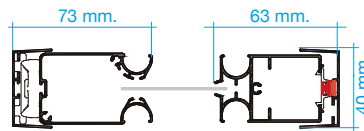

PUERTA DOBLE

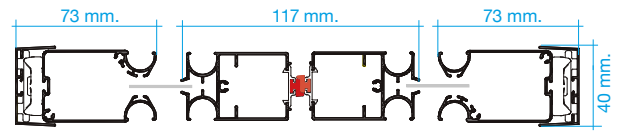

## Precios

		Puerta Única				Puerta Doble			
Alto	Ancho	0,80	1,00	1,20	1,40	1,60	2,00	2,40	2,80
1,75	Grupo 1	184	192	221	257	368	384	441	515
	Grupo 2	189	196	225	262	378	392	449	524
2,00	Grupo 1	191	210	252	294	382	420	504	588
	Grupo 2	195	214	257	300	390	428	514	599
2,25	Grupo 1	205	236	284	331	410	473	567	662
	Grupo 2	212	241	289	337	424	482	578	674
2,50	Grupo 1	212	263	315	368	424	525	630	735
	Grupo 2	218	268	321	375	436	535	642	749

A efectos de precio se redondeará a la inmediata superior.

# Componentes

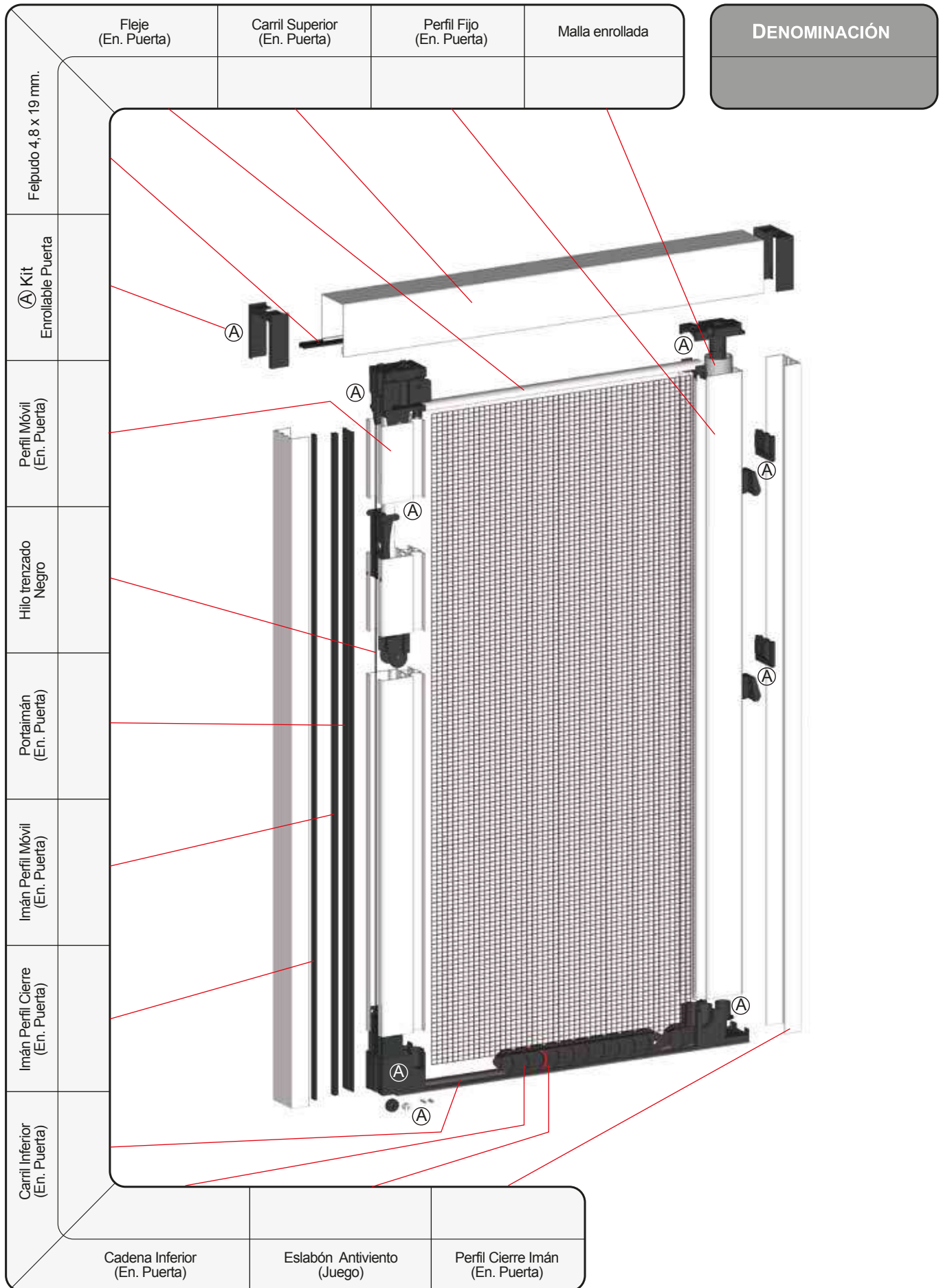

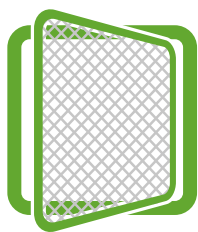

# Abatible Puerta

MEDIDAS A FABRICAR	ABATIBLE	← ANCHO →		↕ ALTO ↕	
		MÍNIMO	MÁXIMO	MÍNIMO	MÁXIMO
	POR HOJA	0,31	1,20	-	2,40

## Colores Estándar

Grupo 1	Grupo 2*	Grupo 3	Grupo 4
- Lacado Blanco 0002	- Ral 1015 - Ral 7016 - Ral 3005 - Ral 7022 - Ral 6005 - Ral 8014 - Ral 6009 - Ral 8017 - Ral 7011 - Ral 9011-Mate	No disponible	No disponible

\*Plazo de entrega 10 días.

¡DE LOS COLORES INDICADOS MANTENEMOS EXISTENCIAS PERMANENTES!  
Podemos suministrar mosquiteras en cualquier otro color de la carta RAL

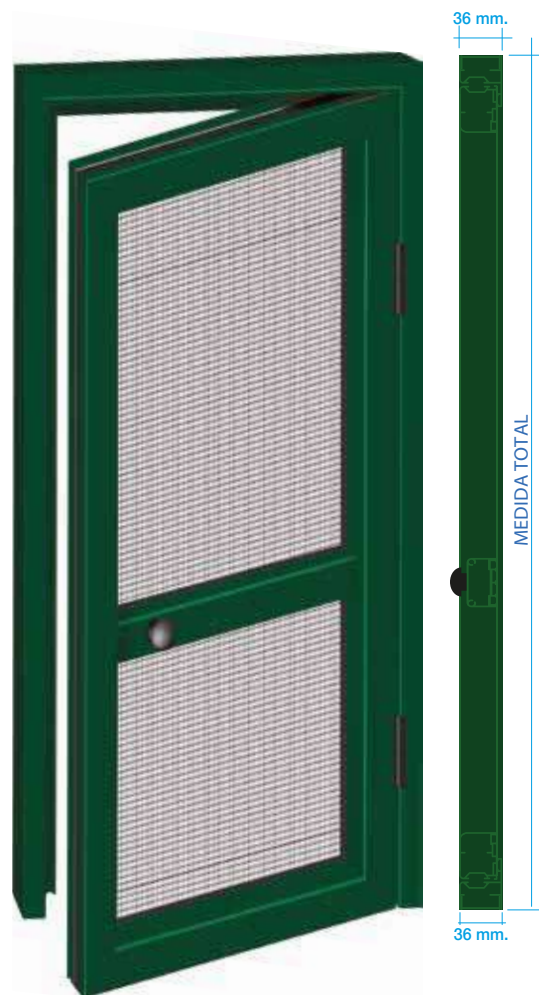

Modelo	Tipología	Nº Hojas	Ancho Máximo cm.
A1		1	120
A2			
A3		2	240
A4			
A5			
A6			

## Precios

		Puerta Única				Puerta Doble			
Alto	Ancho	0,60	0,80	1,00	1,20	1,20	1,60	2,00	2,40
1,80	Grupo 1	232	241	253	264	462	483	512	528
	Grupo 2	257	267	281	294	514	537	568	587
2,00	Grupo 1	240	251	262	274	481	501	524	547
	Grupo 2	267	278	292	304	535	557	582	608
2,20	Grupo 1	266	278	289	301	534	556	579	602
	Grupo 2	296	308	322	335	593	618	643	669
2,40	Grupo 1	275	287	299	311	549	575	597	620
	Grupo 2	305	319	333	345	611	639	663	688

A efectos de precio se redondeará a la inmediata superior.



# Componentes

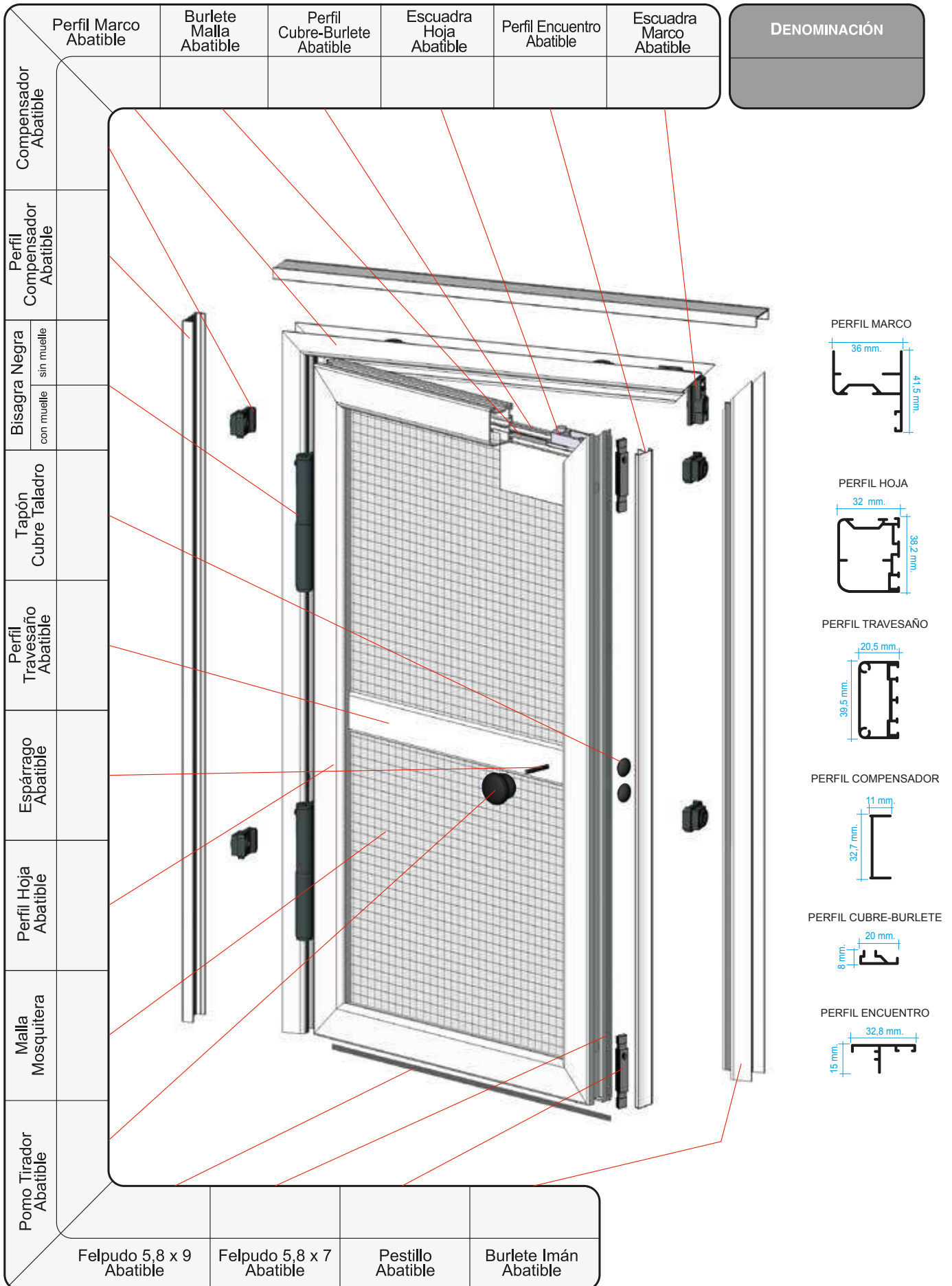

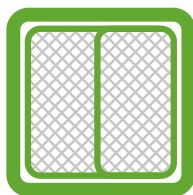

## Fijas y Correderas

PERFIL FIJA



PERFIL TRAVESAÑO

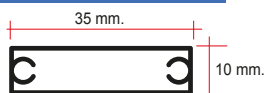

Común para Fija y Corredera

## Componentes Fijas

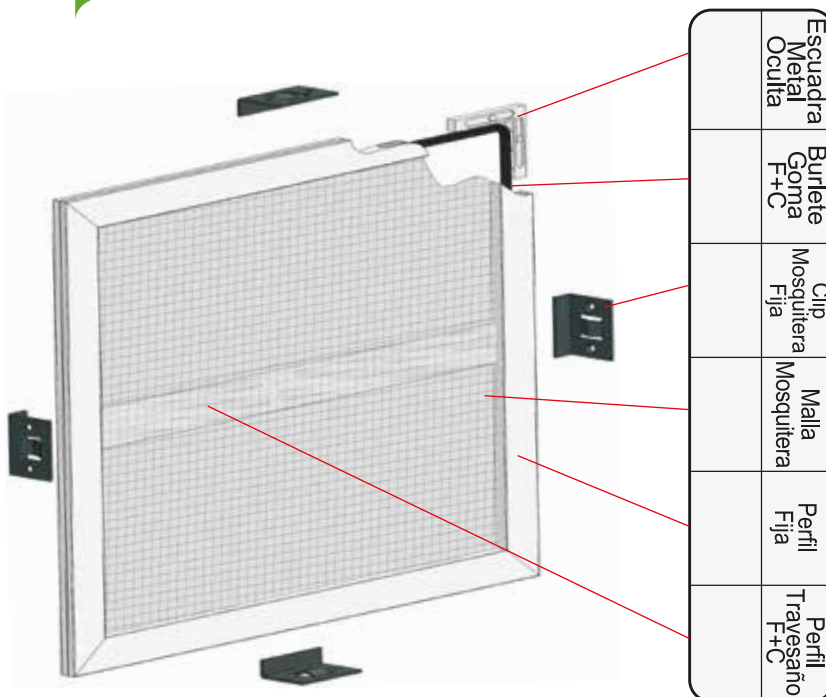

Escuadria Metal Oculta	Burlete Goma F+C	Clip Mosquitera Fija	Red	Red	Red	Red	Red
			Red	Red	Red	Red	Red
			Red	Red	Red	Red	Red
			Red	Red	Red	Red	Red
			Red	Red	Red	Red	Red
			Red	Red	Red	Red	Red
			Red	Red	Red	Red	Red
			Red	Red	Red	Red	Red

MEDIDAS A FABRICAR	FIJA	← ANCHO →		↕ ALTO ↕	
		MÍNIMO	MÁXIMO	MÍNIMO	MÁXIMO
	HOJA	0,27	1,60	0,27	2,20

## Colores Estándar

Grupo 1	Grupo 3	¡DE LOS COLORES INDICADOS MANTENEMOS EXISTENCIAS PERMANENTES! Podemos suministrar mosquiteras en cualquier otro color de la carta RAL .
- Lacado Blanco 0002 - Anodizado Plata 0003	- Anodizado Bronce 0004	

## Precios Fijas

Alto	Ancho					
	0,80	1,00	1,20	1,40	1,60	
1,00	Grupo 1	58	63	66	71	74
	Grupo 3	62	68	72	76	80
1,20	Grupo 1	63	66	71	76	78
	Grupo 3	68	72	76	82	84
1,40	Grupo 1	66	71	76	80	82
	Grupo 3	72	76	82	86	88
1,60	Grupo 1	69	75	80	84	
	Grupo 3	75	81	86	91	
1,80	Grupo 1	75	79	84	89	
	Grupo 3	81	85	91	97	
2,00	Grupo 1	78	82	89	94	
	Grupo 3	84	88	97	101	
2,20	Grupo 1	81	87	94	98	
	Grupo 3	87	95	101	105	

A efectos de precio se redondeará a la inmediata superior.

## Incrementos

DESCRIPCIÓN	Travesaños adicionales	Formas irregulares	Medio punto Ojo de buey Curva monoradio	Curva multiradio
€/Ud. MOSQUITERA	16,30	19,50	65,20	206,50

# Componentes Correderas

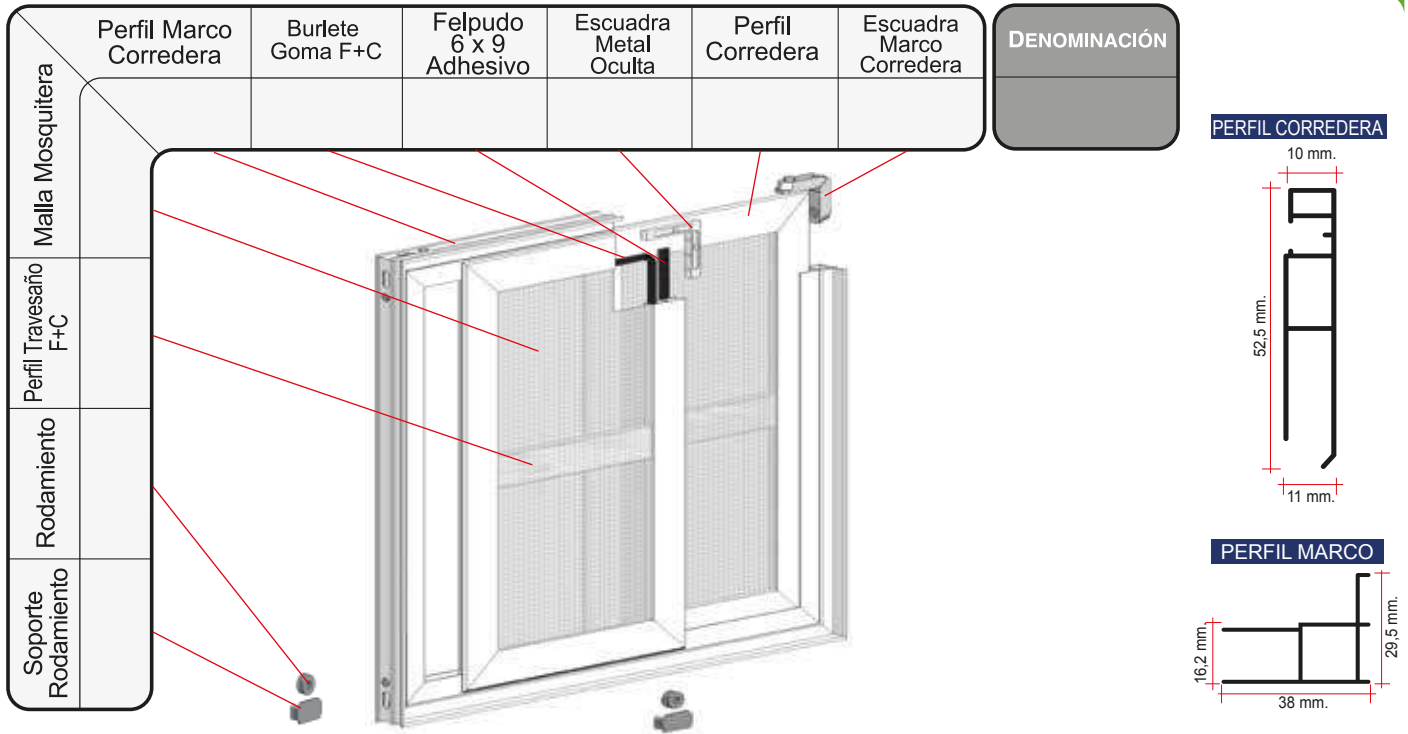

MEDIDAS A FABRICAR	CORREDERA	← ANCHO →		↕ ALTO ↕	
		MÍNIMO	MÁXIMO	MÍNIMO	MÁXIMO
	HOJA	0,32	1,20	0,32	2,20

## Precios Correderas

Alto	Ancho	Marco Hoja	1,20		1,60		2,00		2,40				
			0,60	0,60	0,80	0,80	1,00	1,00	1,20	1,20			
1,00	Grupo 1	Sólo Marco Cada Hoja	62	57	62	67	67	72	75	72	77	82	77
		TOTAL		181		201		219		236		236	
	Grupo 3	Sólo Marco Cada Hoja	67	61	67	73	73	77	81	77	83	88	83
1,20	Grupo 1	Sólo Marco Cada Hoja	66	62	66	71	71	77	79	77	81	86	81
		TOTAL		194		213		233		233		248	
	Grupo 3	Sólo Marco Cada Hoja	72	67	72	76	76	83	85	83	87	94	87
1,40	Grupo 1	Sólo Marco Cada Hoja	76	65	76	81	81	88	82	88	95	91	95
		TOTAL		217		237		258		258		281	
	Grupo 3	Sólo Marco Cada Hoja	82	71	82	87	87	96	88	96	102	98	102
1,60	Grupo 1	Sólo Marco Cada Hoja	79	68	79	86	86	93	86	93	100	94	100
		TOTAL		226		251		272		272		294	
	Grupo 3	Sólo Marco Cada Hoja	85	74	85	94	94	100	94	100	108	101	108
1,80	Grupo 1	Sólo Marco Cada Hoja	83	72	83	91	91	97	91	97	104	97	104
		TOTAL		238		264		285		285		305	
	Grupo 3	Sólo Marco Cada Hoja	89	77	89	98	98	104	98	104	113	104	113
2,00	Grupo 1	Sólo Marco Cada Hoja	88	77	88	95	95	102	94	102	109	102	109
		TOTAL		253		276		298		298		320	
	Grupo 3	Sólo Marco Cada Hoja	96	83	96	102	102	111	101	111	118	111	118
2,20	Grupo 1	Sólo Marco Cada Hoja	93	80	93	100	100	107	97	107	115	105	115
		TOTAL		266		291		311		311		335	
	Grupo 3	Sólo Marco Cada Hoja	100	86	100	108	98	116	104	116	124	114	124
		TOTAL		286		314		336		336		362	



A efectos de precio se redondeará a la inmediata superior.

# Carta de Colores

Grupo 1	Grupo 2	Grupo 3	Grupo 4
Lacado Blanco 0002	Anodizado Plata 0003	Anodizado Bronce 0004	IMITACIÓN MADERA Nogal Oscuro 0007
	Ral 1015	Anodizado INOX 0005	Roble Claro 0008
	Ral 3005	Gris Grafito 0006	Nogal Español 0009
	Ral 6005		Pino Nudo 0010
	Ral 6009		Embero "Texturado" 0011
	Ral 7011		
	Ral 7016		
	Ral 7022		
	Ral 8014		
	Ral 8017		
	Ral 9011-Mate		

Estos colores son orientativos y pueden tener diferencias con los reales.